

VOLANT COOL AIR INTAKES  
 PART NO.: 16859  
 INSTALLATION INSTRUCTIONS  
 WWW.VOLANT.COM  
 TECH SUPPORT: (909) 481-3888

16859 PARTS LIST					
1	VOLANT FILTER BOX	1	1/4" NUT	1	1/4" KNURLED NUT
1	VOLANT FILTER BOX LID	1	1/4" LOCK WASHER	1	THRDTLE BODY STUD
1	VOLANT AIR DUCT	1	1/4" FENDER WASHER	1	1 1/2" RUBBER BUMPER
1	RAM FILTER W/CLAMP	1	1/4" RUBBER FENDER WASHER	1	RUBBER GASKET
2	#056 CLAMPS	4	1/4"-20 TRUSS HEAD SCREWS	1	5/8" X 3/4" NPT FITTING
1	3 1/2" HUMP HOSE	4	1/4" RUBBER WASHERS		
1	1/4"-20 BOLT	1	BLACK TREE RIVOT		

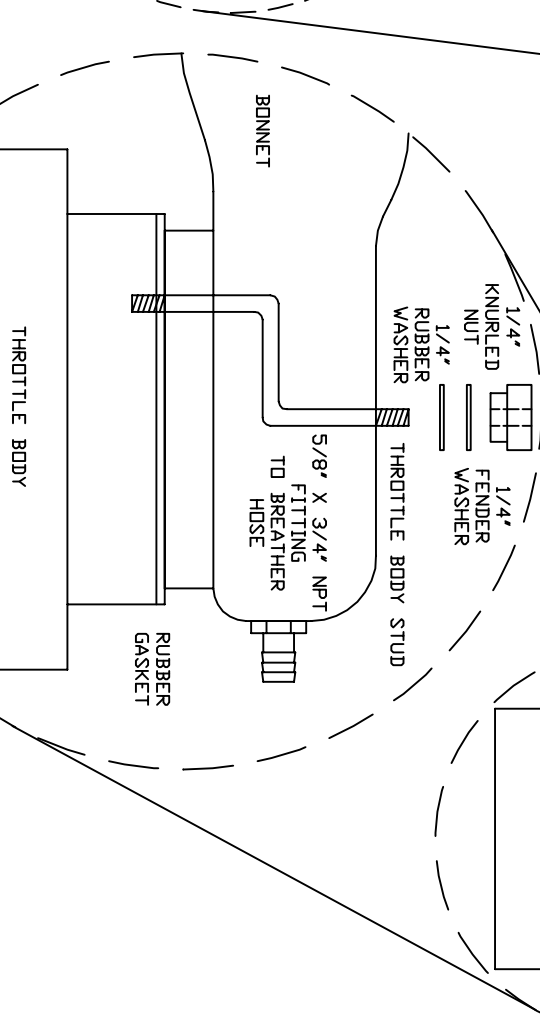
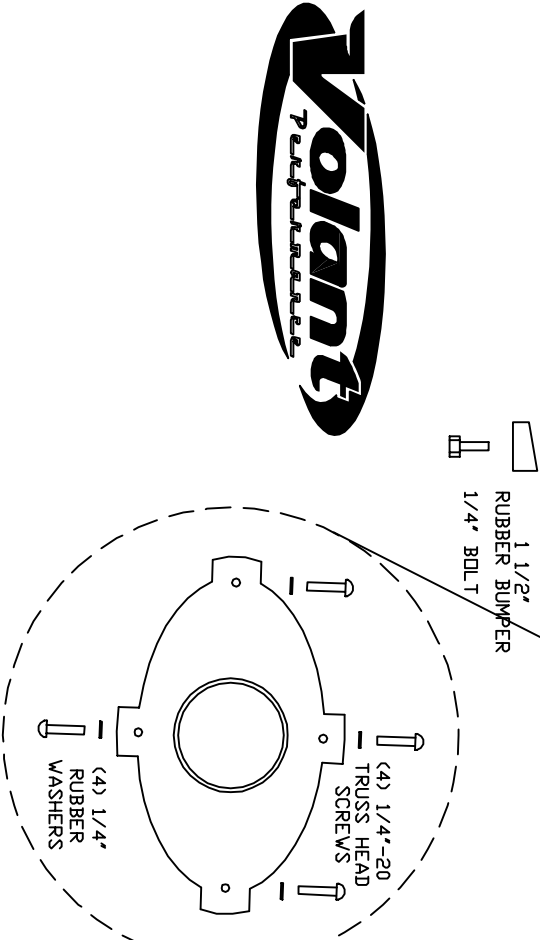
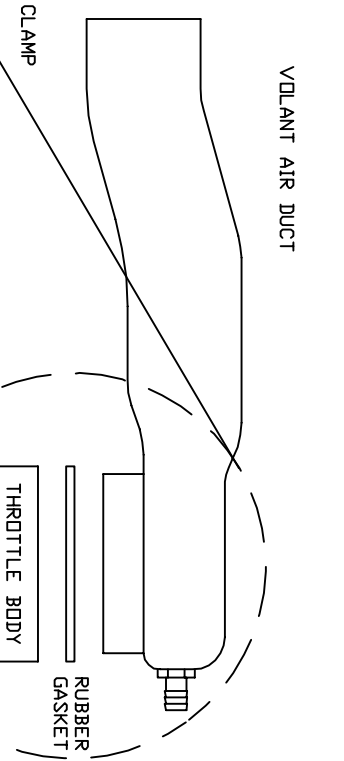
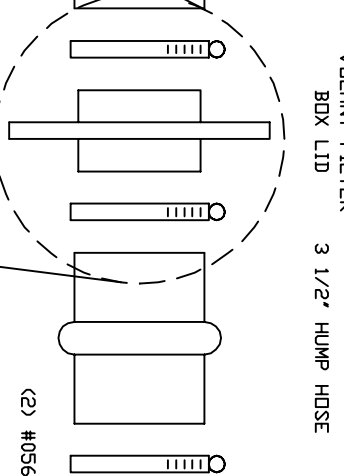
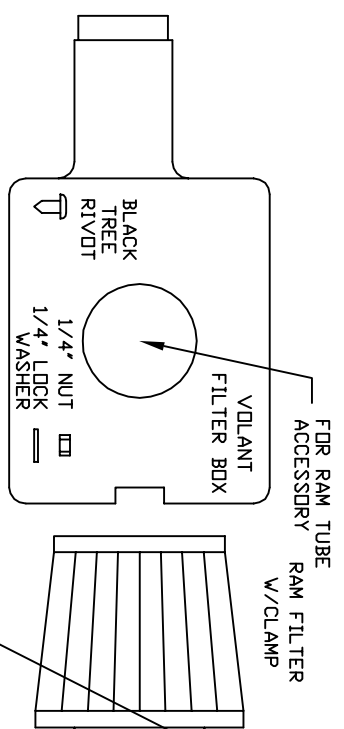

FRONTAL VIEW OF  
 FILTER BOX COVER

FIG. A



9400 7TH ST. UNIT C-1  
Rancho Cucamonga, CA 91730  
(909) 476-7225 TECH SUPPORT  
(909) 476-1491 FAX  
www.volantperformance.com

**PART NO. 16859**

MAKE	MODEL	YEAR	LITER
DODGE	RAM	94-00	3.9/5.2/5.9

**ACCESSORIES:**

	PART NO.
VOLANT REPLACEMENT FILTER	5117
AIR FILTER CLEANER KIT	5100
VOLANT PREFILTER	51902

**INSTALLATION INSTRUCTIONS PART NO. 16859**

READ INSTRUCTIONS THOROUGHLY BEFORE DISASSEMBLING. DO NOT SKIP ANY STEPS. ANY QUESTIONS ON A VOLANT KIT MAY BE REFERRED TO OUR TECH SUPPORT LINE AT (909) 476-7225 OR VISIT OUR WEBSITE AT WWW.VOLANTPERFORMANCE.COM

**TOOLS NEEDED FOR INSTALL:**

1. FLATHEAD SCREWDRIVER OR 5/16 NUT DRIVER
2. PHILLIPS SCREWDRIVER

**INSTALLATION:**

1. Switch vehicle ignition to the off position and disconnect negative battery cable.
2. Pull the long stock square air duct hose that pulls the air into your throttle body away from the fender well. Then pull it off the stock filter box and away from your engine compartment.
3. Disconnect valve cover breather hose from stock filter box assembly located on top of your throttle body. Then unscrew the large clamp with your screwdriver that holds your stock filter box to the throttle body. Then remove entire stock filter box assembly from the engine compartment.
4. Install the Volant filter box assembly without the lid to the existing opening where the stock air duct pulls its air. Fasten the Volant filter box to the trucks fender well by using the black tree rivot provided by Volant. Install high performance ram filter w/clamp to the oval end of the Volant filter box lid. Fasten the Volant filter box lid to the Volant filter box with four (4) 1/4"-20 truss head screws and four (4) 1/4" rubber washers.

5. Install the Volant throttle body rubber gasket.
6. Hand screw Volant throttle body stud to the middle of the throttle body. Insert the throttle body stud threw the bonnet of the Volant air duct. Attach the 1/4" knurled nut, 1/4" fender washer and 1/4" rubber fender washer over the stud. **DO NOT completely tighten.**
7. Connect the 3 1/2" hump hose to the Volant air duct and Volant filter box lid using the #056 clamps provided. Close and tighten.
8. Connect the stock valve breather hose to the 5/8" X 3/4" NPT fitting on the Volant air duct. Completely tighten knurled nut to seal onto the throttle body.
9. Make sure everything is properly connected and all clamps are tightened.
10. Reconnect negative battery cable.
11. Place the C.A.R.B. label on or near the Volant system in the engine compartment.

**WARNING: OVER TIGHTENING HARDWARE MAY ALTAR THE INTEGRITY OF THE VOLANT AIR INTAKE SYSTEM.**

**BEFORE ROAD TESTING**

1. Start engine, leaving the transmission in park and securing the parking brake.
2. Make sure to look and listen for any unusual noises or air leaks. Repair problems if needed.
3. Once completed it will be necessary to check periodically for realignment and tightening of all connections.
4. Once all tests are completed, enjoy the performance of your new Volant Air Intake System.

**CARE AND CLEANING**

Check the cotton reusable filter periodically and remove any excessive dirt build-up by tapping the filter on the ground and brushing off the loosened dirt. Clean the filter by using Volant's Filter Recharger Kit. Volant's Filter Recharger Kit is designed to restore original air flow. Re-oil every 10,000 miles without cleaning to improve filtering in sand and dirt. Clean only when dirt is very excessive or 50,000 miles.

**16859 INSTALLATION**

List of component parts (please confirm that you have all parts before starting the installation)

- 1 VOLANT FILTER BOX
- 1 VOLANT FILTER BOX LID
- 1 VOLANT AIR DUCT
- 1 RAM FILTER W/CLAMP
- 2 #056 CLAMPS
- 1 3 1/2" HUMP HOSE
- 1 1/4"-20 BOLT
- 1 1/4" NUT
- 1 1/4" LOCK WASHER
- 1 1/4" FENDER WASHER
- 1 1/4" RUBBER FENDER WASHER
- 4 1/4"-20 TRUSS HEAD SCREWS
- 4 1/4" RUBBER WASHERS
- 1 BLACK TREE RIVOT
- 1 1/4" KNURLED NUT
- 1 THROTTLE BODY STUD
- 1 1 1/2" RUBBER BUMPER
- 1 RUBBER GASKET
- 1 5/8" X 3/4" NPT FITTING

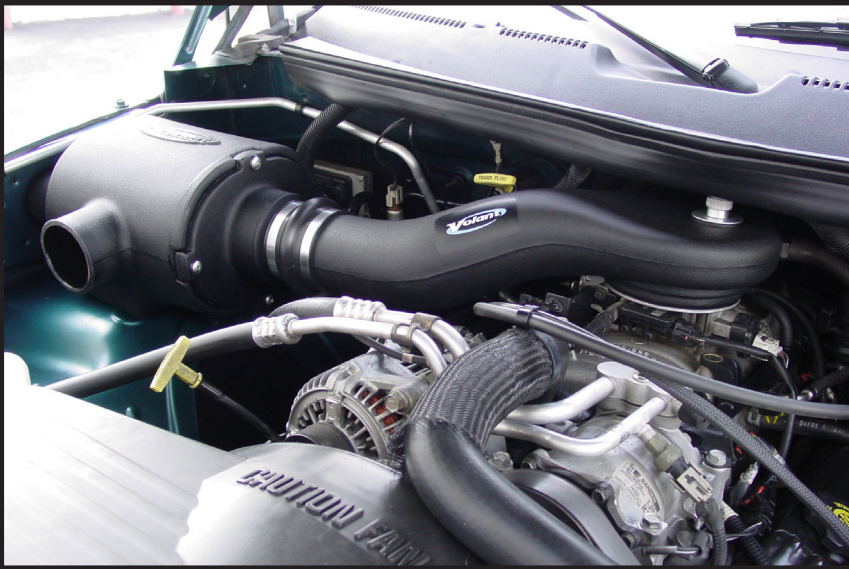

VOLANT AIR INTAKE SYSTEMS  
 DODGE 94-01 3.9/5.2/5.9L RAM SCOOP  
 PART NO.: 36859  
 INSTALLATION INSTRUCTIONS  
 OFF ROAD USE ONLY  
 WWW.VOLANTPERFORMANCE.COM  
 TECH SUPPORT: (909) 476-7225

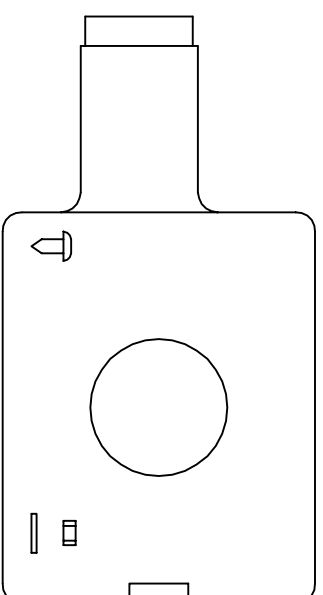
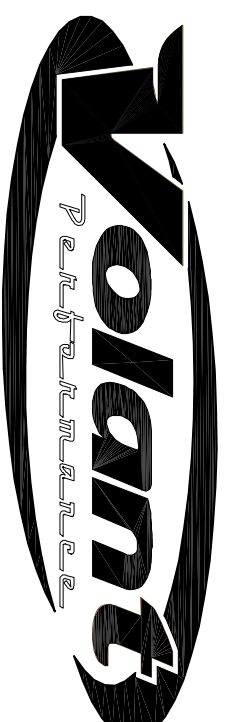

VOLANT FILTER BOX  
 NOT INCLUDED WITH  
 RAM AIR SCOOP  
 ACCESSORY

RAM AIR SCOOP ACCESSORY	
1	VOLANT RAM AIR SCOOP
1	3 1/2" X 3" SLEEVE
2	#056 CLAMPS

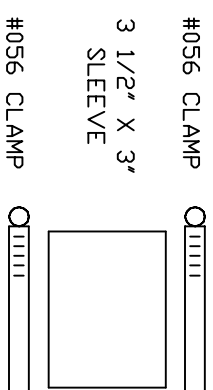

#056 CLAMP

#056 CLAMP

SIDE VIEW

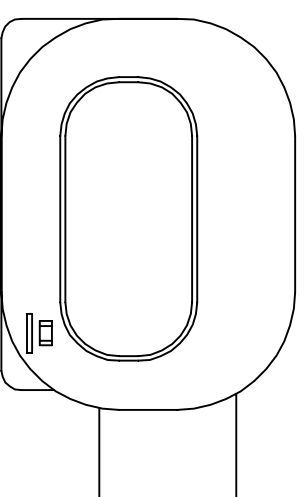

VOLANT RAM  
 AIR SCOOP

3 1/2" X 3"  
 SLEEVE

VOLANT RAM  
 AIR SCOOP

TOP  
 VIEW



HEADLAMP



RADIATOR