



INSTALLATION INSTRUCTIONS



2021 FORD BRONCO OVERLAND | PART NO. 19559

BILL OF MATERIALS:

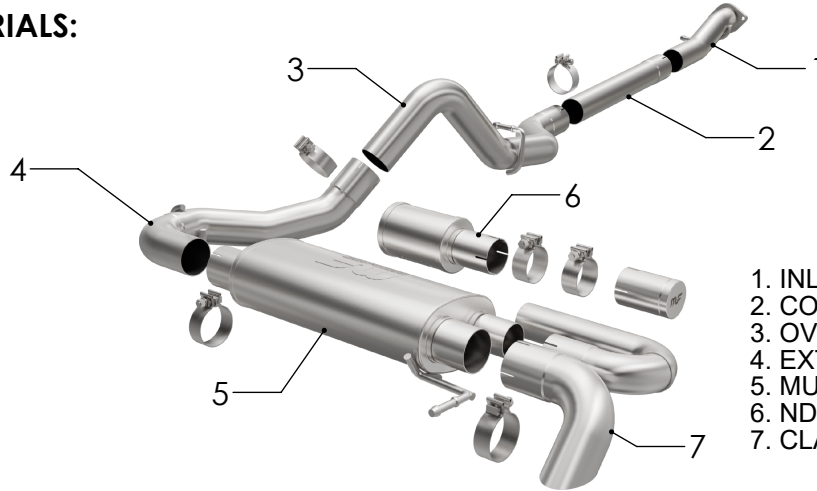

- 1. INLET PIPE ASSEMBLY
- 2. CONNECTOR PIPE
- 3. OVER AXLE ASSEMBLY
- 4. EXTENSION PIPE ASSEMBLY
- 5. MUFFLER ASSEMBLY
- 6. NDT RESONATOR
- 7. CLAMP-ON TIP



WEAR SAFETY GLASSES



READ INSTRUCTIONS THOROUGHLY BEFORE INSTALLING PRODUCT



SPRAY LUBRICANT

To ease removal of existing exhaust components (especially on older vehicles) spray penetrating lubricant on all fasteners and hangers/insulators that will be loosened or removed and let soak before disassembly.

SHOP SUPPLIES:

HARDWARE KIT:

- 1. [2] 2.50" Band Clamp
- 2. [5] 3.00" Band Clamp
- 3. [1] MF Block Off Pipe

MINIMUM REQUIRED TOOLS:



15mm



Hanger Tool (Or Pry Bar)

MAGNAFLOW RECOMMENDS PROFESSIONAL INSTALLATION ON ALL THEIR PRODUCTS



WARNING: When working on, under, or around any vehicle exercise caution. Please allow the vehicle's exhaust system to cool before removal, as exhaust system temperatures may cause severe burns. If working without a lift always consult vehicle manual for correct lifting specifications. Always wear safety glasses and ensure a safe work area. Serious injury or death could occur if safety measures are not followed.

ATTENTION: Always install any supplied band or V-band clamps to the proper torque specifications of 40-45 ft-lbs for band clamps and 70 in-lbs for V-band clamps. Over tightening will result in the clamp breaking and will NOT be warranted by MagnaFlow.

MAGNAFLOW: 1901 Corporate Centre Dr - Oceanside, CA 92056 | 1(800)990-0905

Technical Support: 1(800) 959-9226 | Email: moreinfo@magnaflow.com

INSTALLATION INSTRUCTIONS



Begin removal of the OE exhaust system by removing the fasteners attaching the exhaust to the flex pipe.

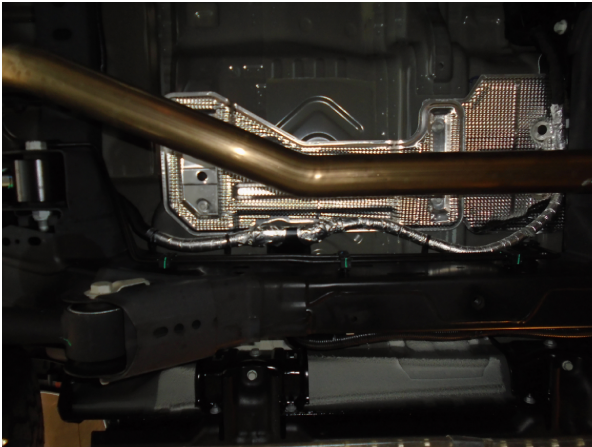

With the system supported, working front to rear disengage the hangers from rubber insulators and remove the OE system. Do not discard or damage the clamp or rubber insulators as they will be used to install the new system.

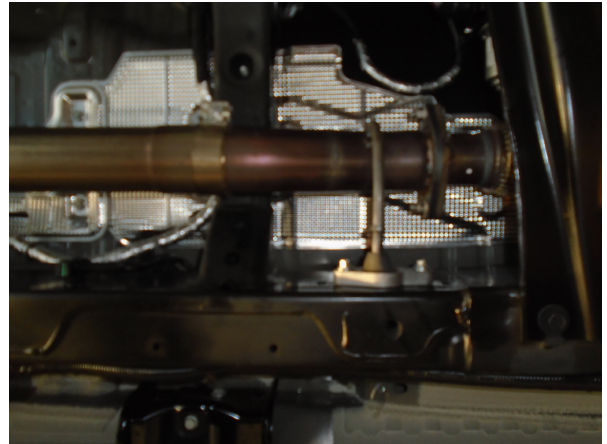

Begin installation of your new MAGNAFLOW system by attaching the Inlet Pipe Assembly to the flex pipe using the OE Fasteners. Engage the welded hanger to the rubber insulators. Keep all fasteners and clamps loose until final adjustment.

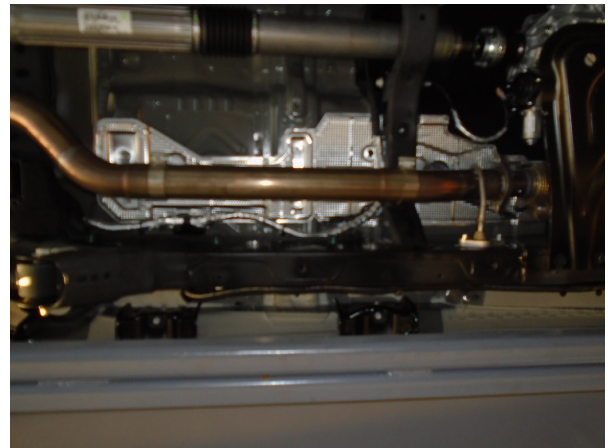

The included Connector Pipe is required for the four door model only. It is to be installed between the Inlet Assembly and the Over-Axle Pipe. If you have the two door model this pipe may be discarded.

INSTALLATION INSTRUCTIONS

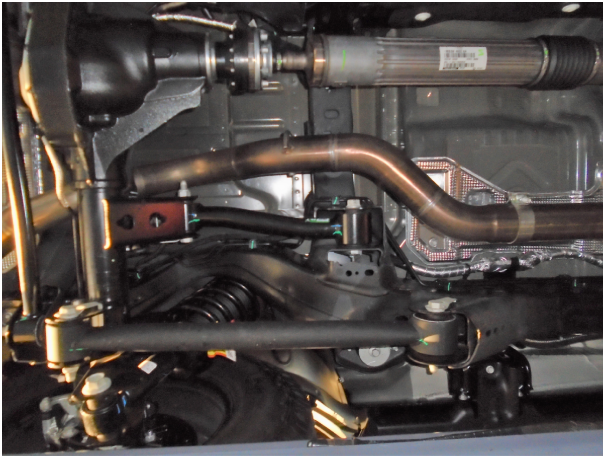

Step 5: Next loosely install the Over-Axle and Extension Pipe Assemblies using the supplied 3.00" clamps. Locate all welded hangers to the rubber insulators.

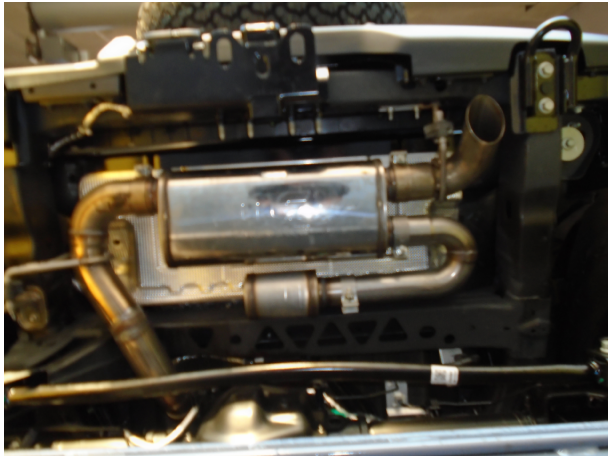

Step 6: Next attach the Oval Muffler to the Extension Pipe Assembly with the supplied 3.00" clamp. This exhaust system is configured to allow the user to tune the sound. For a more moderate exhaust sound install the U-pipe Assy and the 4.00" NDT Chamber (as shown) using the supplied 2.50" clamps. For a more aggressive sound see configuration chart.

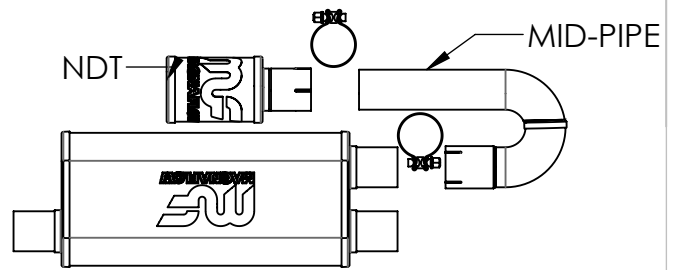

CONFIGURATION # 1

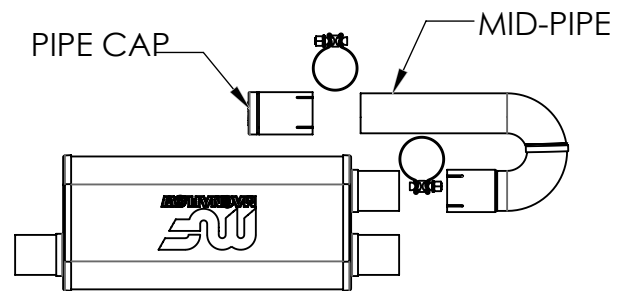

CONFIGURATION # 2

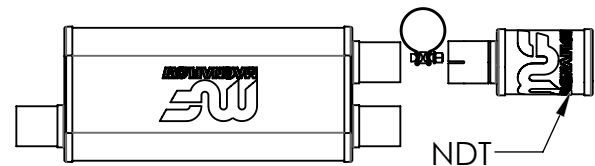

CONFIGURATION # 3

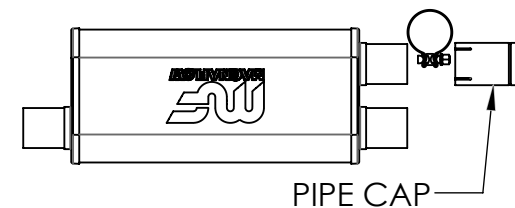

CONFIGURATION # 4

INSTALLATION INSTRUCTIONS

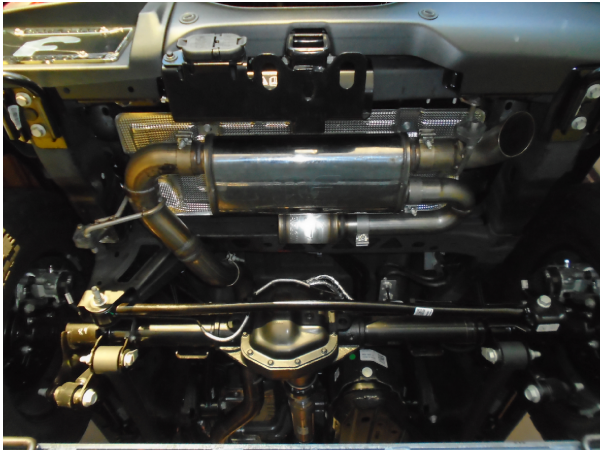

MAGNAFLOW: 1901 Corporate Centre Dr - Oceanside, CA 92056 | 1(800)990-0905
Technical Support: 1(800) 959-9226 | Email: moreinfo@magnaflow.com