



34935 Flyover Ct. Bakersfield, CA 93308
Phone: (661) 588-8085 | Fax: (661) 588-8295

INSTALL INSTRUCTIONS:
Cognito 1" Standard Leveling Kit for 2019-2020, GMC Sierra 1500 AT4, Chevy Silverado 1500 Trail Boss, 2WD/4WD Trucks.
SKU: 110-90767



WARNING

Please read this entire instruction sheet before beginning installation. Proper installation of these components requires a qualified mechanic. Always wear safety glasses when using power tools, and take appropriate precautions when working under a vehicle. If these instructions are not properly followed you may jeopardize your, and your passenger's safety, and severe frame, suspension or tire damage may also result from improper installation.

PARTS LIST FOR SKU: 110-90767

QTY.	PART #	DESCRIPTION
2	90763	STRUT SPACER .75INCH 2T 2019 GMC 1500
1	HP9270	STRUT SPACER HARDWARE
1	8693	2019 GM 1500 Tubular Bolt-In Arm, Driver
1	8694	2019 GM 1500 Tubular Bolt-In Arm, Passenger
1	HP9262	Bushing Kit for Cognito Upper Control Arms on 2019 GM 1500 2WD & 4WD trucks3
2	199-90722	Ball joint, bolt in, application for Cognito upper arm, 2019 GM 1500
1	HP9274	Ball Joint Hardware Kit: includes hardware for 2 ball joints.

PARTS LIST FOR SKU: HP9274

QTY.	PART #	DESCRIPTION
16	HARDWARE-33080	33080 5/16 Sae F/W Z..
8	HARDWARE-37262	37262 5/16-18 Grade C Zinc Plated Top Lock Nut
4	HARDWARE-15057	15057 5/16"-18 X 1-1/4" G8 YZ Hex Cap Screw

PARTS LIST FOR SKU: HP9270

QTY.	PART #	DESCRIPTION
6	HARDWARE-M10X1.5-FNUT	M10 X 1.5 Zinc Plated Serrated Hex Flange Lock Nut
1	HARDWARE-0708765	1/2" Wire/Tube P Clamp W/Vinyl Cushion
2	HARDWARE-63124	1/2" Wire/Tube P Clamp W/Vinyl Cushion

PARTS LIST FOR SKU: HP9262

QTY.	PART #	DESCRIPTION
4	5024	Crush Sleeve 1.0 X .219 X 2.130 Dom
8	POLY-BUSHING-2757	Black Polyurethane Spring Bushing
4	6468	UCA Bushing Thrust Washer
4	UCA Bushing Thrust Washer	58792 1/4-28" Self-Tapping 90D Angle-Zerk Grease Fitting Utility

REQUIREMENTS

- Installation requires a qualified mechanic.
- Read instructions carefully and study the pictures before attempting installation.
- Check the parts and hardware packages against the parts list to assure that your kit is complete.
- **This kit is only for the AT4 Trail Boss.**
- **This kit is not compatible with models equipped with Adaptive Ride Control.**
- Compatible with most OEM Wheels and Tires.

TECHNICAL INFORMATION

- Cutting and sanding the studs on the factory struts is required.
- Compressing the strut spring is required.
- Depending on your wheel and tire combination, trimming of inner fender and valance will be required.

INSTALLATION

1. If your truck has an ARC link as shown in figure 1, this kit will not fit.
2. Start by racking the vehicle and hoisting it off the ground, or if no hoist is available then jack the front of the truck off the ground and support properly with jack stands. NEVER WORK ON AN UNSUPPORTED VEHICLE.
3. Remove the factory upper control arms. Loosen the ball joint nut of the upper control arm until you can spin the nut with your fingers, but do not fully remove it. Use a pickle fork to separate the ball joint from the spindle, or tap on the side of the spindle next to the ball joint stud with a hammer (see figure 1). When the tapered seat of the ball joint breaks loose, you may then remove the ball joint nut, and separate the factory upper control arms from the spindles.

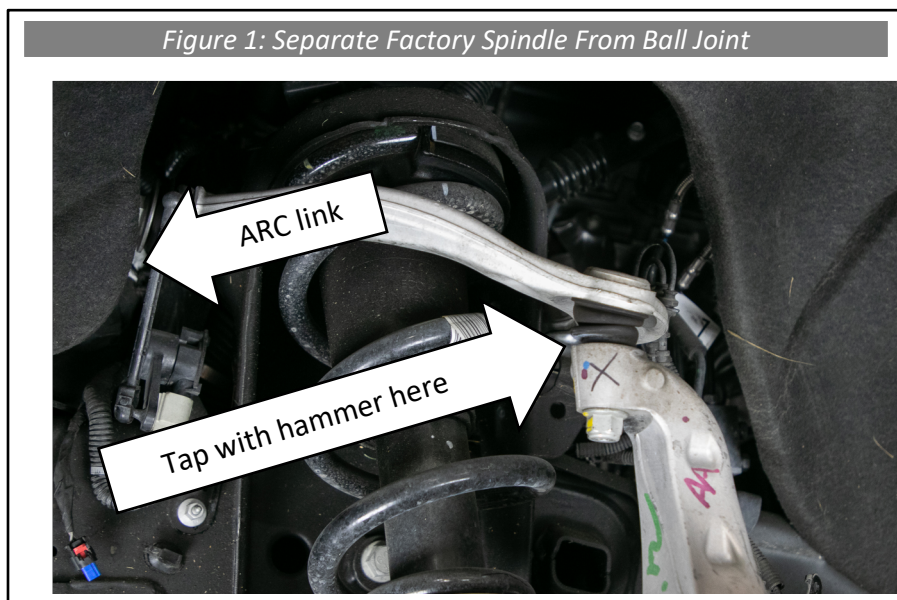

4. Use a 21mm wrench to remove the factory bolts that connect the control arm to the frame, but retain them for future use. Place them aside in order so they can be re-installed in the same place they came off.

- Note that at this time the lower strut screws are holding the lower control arm and spindle in place. Make sure there is a jack stand or other suitable support under the lower ball joint and remove the lower strut screws using a 15mm wrench (see figure 2).

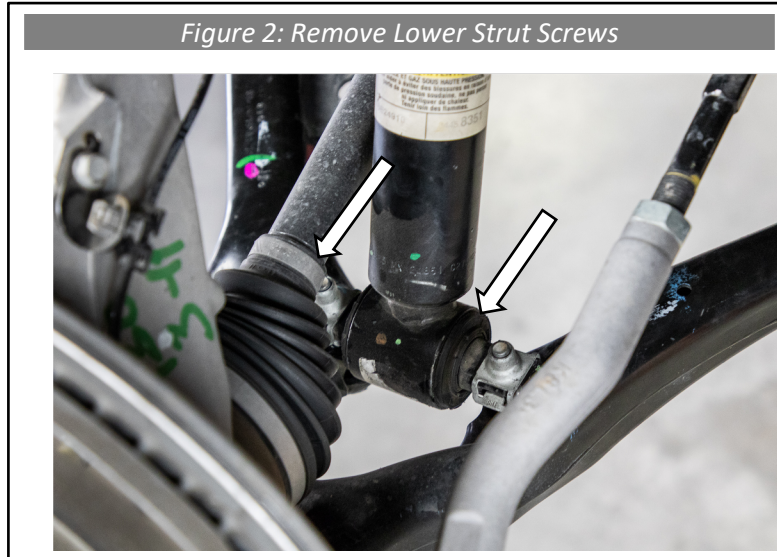

- Next remove the upper strut bolts. There are 3 of them and they require an 18 mm wrench. The plastic wire chase on the passenger side can be pushed upward enough to get the front 2 off easily (see figure 3). The 3rd in the back is somewhat difficult to remove from the wheel well but can be removed from the engine bay if necessary.

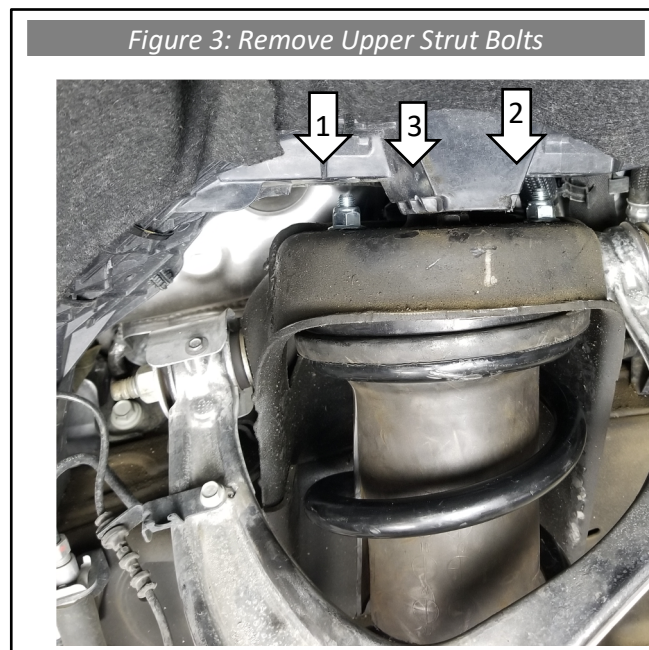

- Using a shock or shock spacers that are too long will cause the upper ball joint to bind and break. Therefore, the OEM shock (or correct length shock) must be used along with this leveling kit. If you have an aftermarket shock, be sure it has the same extended length as the OEM shock from the same vehicle by measuring mounting surface to mounting surface. Measure from the top surface of the strut hat to the "dimple" feature on the lower pivot axis bar pin (see figure 4). This measurement should be 23.00" plus or minus 1/8". If anything is used longer than the guidelines specified, warranty will be void and you could damage your upper arms and ball joints and more, which could cause an accident and even death.

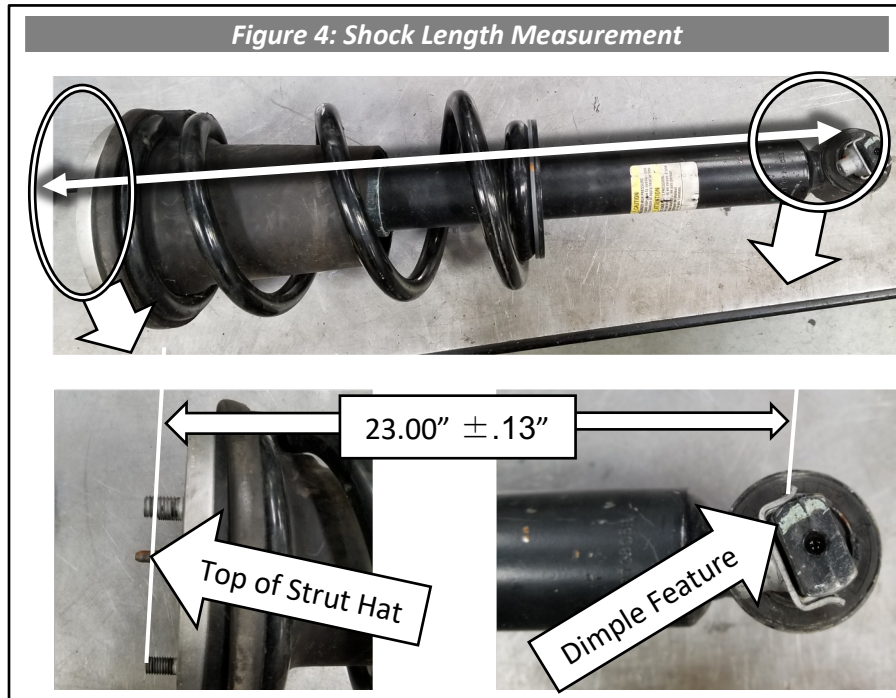

- From the hardware package, insert the polyurethane bushings, crush sleeves, and grease fittings into the ends of the upper control arms. If needed, use WD-40 to aid installation of bushings into the UCA pivot tubes, do not use grease. Do not over tighten the grease fittings, tighten until they are snug and pointing outward toward the tire (See figure 5).

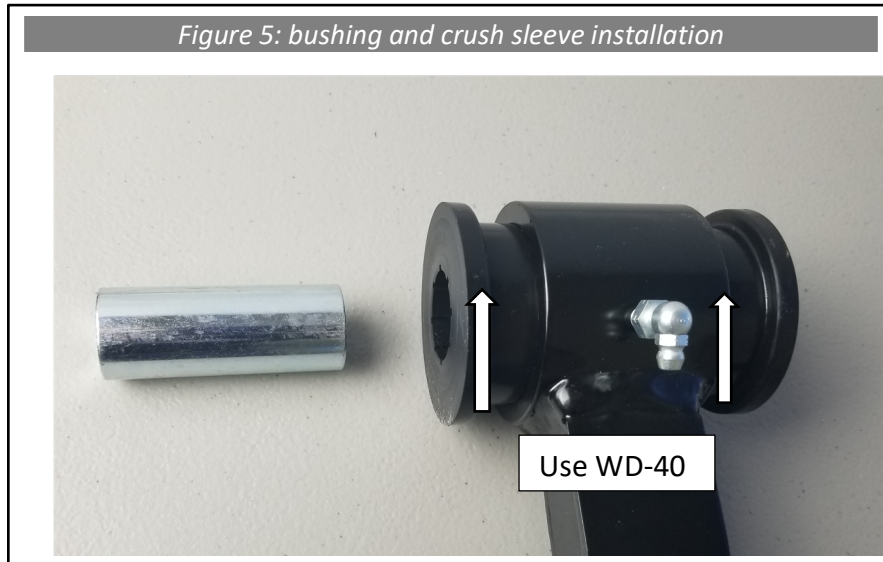

- Mount the Cognito upper control arms to the frame with the factory nuts and bolts using the thrust washers on the exposed side of each bushing. Position the arm near the ride height position and torque to 90 ft-lbs (see figure 6)

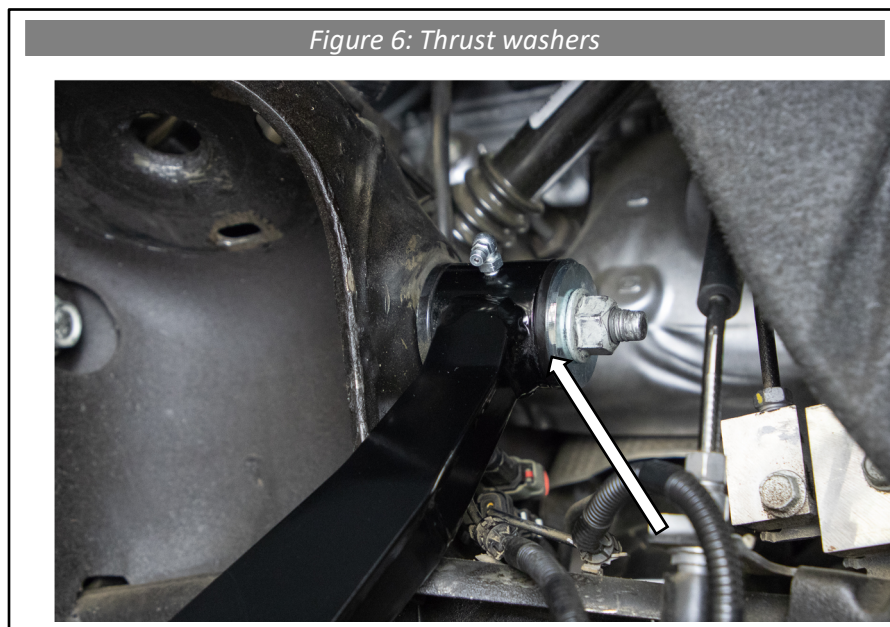

- Place the strut in a spring compressor, locate the lobe feature on the strut hat, and mark the shock tube directly below the lobe as shown in figure 7 for alignment purposes. Add some pressure to the strut assembly and loosen the center nut using an 18mm socket and impact gun. Note that leaving some tension from the spring on the hat will help prevent the piston rod from spinning while using the impact. The nut can also be removed by using an 18mm and 6mm wrench in combination to prevent the piston rod from turning. Once the center nut is loose or off, rotate the shock tube 180° from its original position below the lobe feature on the strut hat. The mark should now be opposite to the lobe feature (see figure 8). Reinstall the sock rod nut in the reverse of its removal.

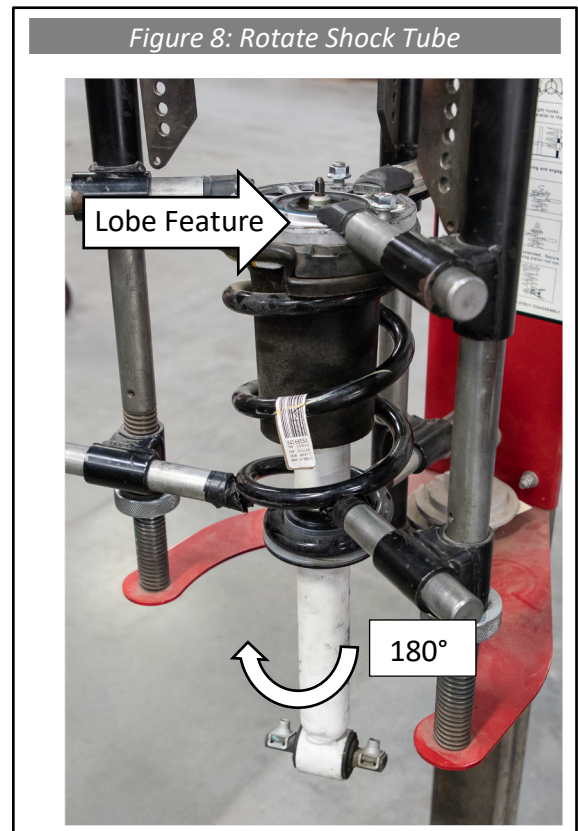
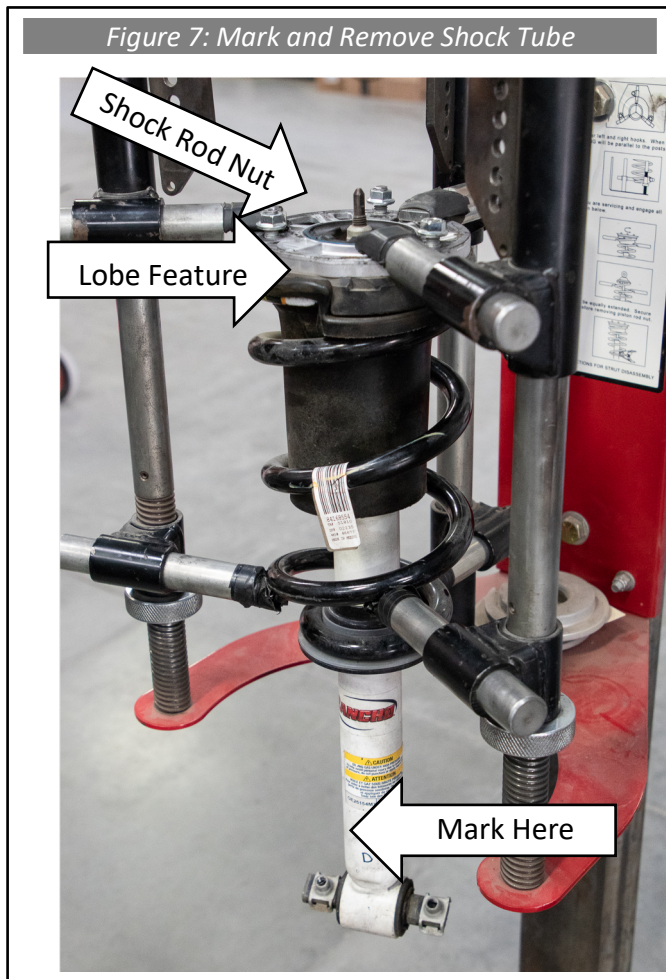

11. Install the supplied m10x1.5 lock nuts all the way down the studs but do not tighten. Mark each stud .7-.75 inches from the top of the strut hat. Cut the studs off on this mark, if they are left a little long to make sure you don't cut them too short, you can touch up the length with the sanding disk in the next step, just at least get the bulk of the excess stud cut off now. You can use a sanding wheel to add a small chamfer and remove burrs from the cut area as shown in figure 9. Now the nuts can be removed.

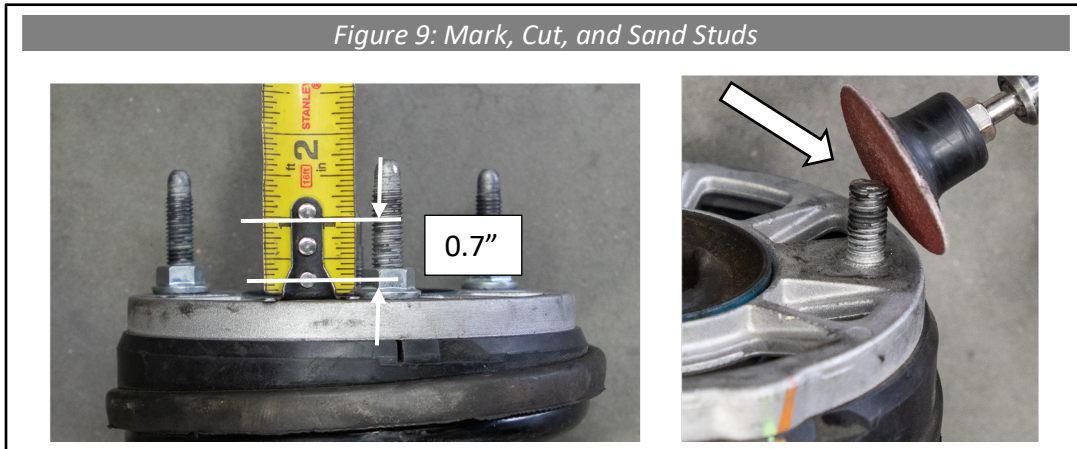

12. Check the stud length by sliding the spacer on and using a straight edge, confirm that the stud does not protrude from the top plane of the spacer (see figure 10). If any do, they must be sanded down until they are flush or below the top of spacer plane. Install the provided m10x1.5 locking flange nuts and torque to 40 ft-lb. There should be visible thread(s) showing past the nut.

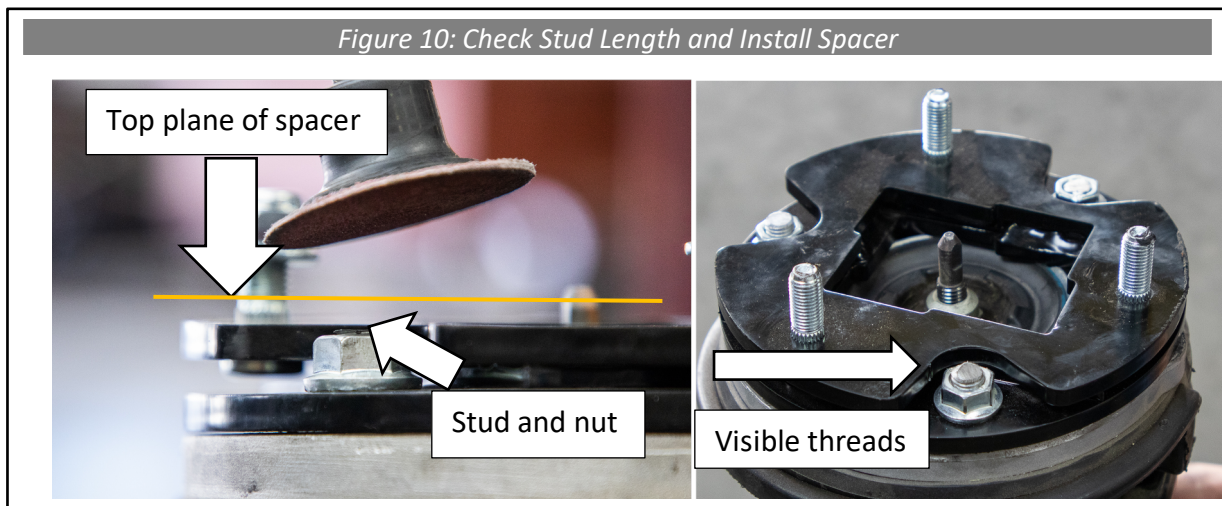

13. Install the strut assembly back on the truck using the m10x1.25 nylon lock nuts provided and torque to 45 ft-lb (see figure 11). Use a pin to help line up the lower strut screws as seen in figure 12 and torque to 40 ft-lb. You will notice that it may be necessary to push on or gently pry the strut in order to get it to fit in its original mounting location, but this is of no concern. The Cognito spacers have the necessary taper built in so the shock is straight at the ride height position.



14. Use a very small amount of ANTI-SEIZE and attach the Cognito upper control arm to the spindle using the M12 castle nut and cotter pin provided. Torque the M12 nut on the bottom to 50 ft/lbs using a 19MM wrench or socket. Install the cotter pin.
15. With the extra droop length you now have with this kit, a cable retaining bracket will contact the shock on the drivers side while steering the vehicle under normal operating conditions. Therefore, it is necessary to replace the wheel speed and brake pad wear sensor wire bracket on the driver's side with a provided P-clamp. Remove the 10mm screw from the back side of the spindle. Use the same mounting position and screw to mount the P-clamp. Use the provided wire ties to neatly retain the wires to the brake line (see figure 13).

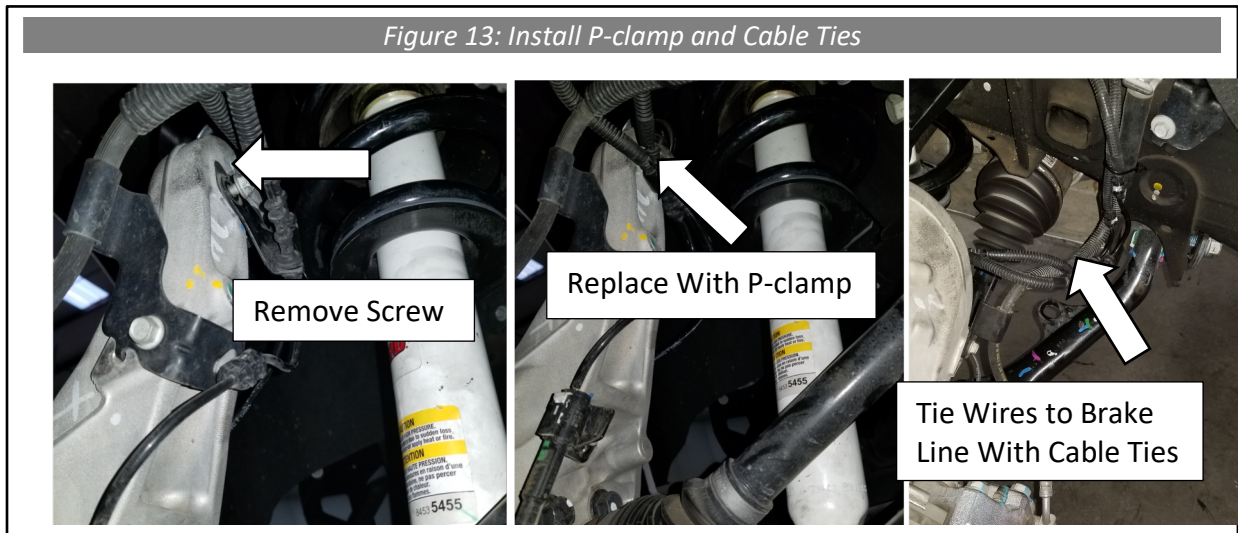

16. If there were factory lines mounted to the factory upper control arms such as ABS or brake lines, they must be restrained as to avoid binding and contact with any moving parts of the vehicle. Use cable ties to restrain the ABS line to the brake line on the passenger side. The driver side may have an additional line for the brake pad wear sensor and can be tied to the brake line as well. Make sure the Cognito arm and shock is fully installed and the front suspension is at full droop. Check that all tied lines are free of stress during the complete steering cycle. After the wheels are back on and the truck is sitting on the ground, check this again. Be sure there is no rubbing or loose cables anywhere.

17. Adjust the headlights per owner's manual, we find that 2.5 turns is pretty good.

18. If any parts other than what is included in this Cognito 110-90767 kit are used, the max ride height and shock length must be checked (reference figure 14 and Table 1). Lift the truck so that the front wheels are off the ground ensuring the suspension is at full droop. Put a piece of masking tape at the top of the wheel well directly above the center line of the wheel. Take a measurement from the taped mark to the top of tire and record it as (A) in table 1. Subtract 3 inches from A and record this number as (B). Set the truck back on the ground, drive it backward 15-20 feet, then forward to the starting point so the suspension settles out. Record this measurement from the same point on the tape to the top of tire again and record it as (C).



Table 1

Full Droop	A	
Max Ride Height	B = A - 3	
Current Ride Height	C	

If (C) is larger than (B), the ride height is too tall. This can be caused by shocks that are too long, too tall of a shock spacer, stacked shock spacers, spring preload devices, or any combination of the above.

19. Have the vehicle's front end professionally aligned using these front end alignment guidelines:

Some Cognito upper control arms have added caster built into them to increase drivability performance, therefore it's important to be sure the correct control arm is installed on the correct side of the vehicle. It's also important to make your alignment shop aware that if caster is higher than normal for OEM, that is the intention by design.

Cross caster is important in making your vehicle track straight down the road. Most roads have crown to them, high in the middle for water runoff. This crown will make your vehicle want to pull to the right. Vehicles with stock tires on them have a narrow contact patch on the ground and are not as affected as a vehicle having larger wider tires. With larger wider tires it's important to have cross caster proper in order for the vehicle to track straight on these roads. Trucks with dual rear wheels have more tire on the ground and require more cross caster. The length of the wheelbase will also affect cross caster needed.

Generally, crew cab short and long bed trucks like .8 degrees of cross caster. For example, the driver side would have 2° while the passenger side would have 2.8° of caster. Dual rear wheel trucks like .9-1.0 degrees of cross caster. Your area might have roads that are crowned more or less than average therefore these numbers may need to change and your alignment shop should understand this. If your alignment tech is stating they can't align the truck, that typically means they can't get the alignment to OEM spec, and that's fine because your vehicle is no longer OEM. A good tech will understand this and the numbers and let caster run slightly out of OEM spec (Caster should always be above 2 degrees positive) while maintaining cross caster needed for the vehicle and roads so you enjoy your vehicle with aftermarket Cognito parts and your driving experience. Camber should always be from $-.1^{\circ}$ to $+.1^{\circ}$ and toe should always be .125" to .250" toe in for best tire wear.

WARRANTY / RETURN POLICY / SAFETY

Cognito Limited Lifetime Warranty

Cognito Motorsports, Inc. hereinafter "Cognito," warrants to the original retail purchaser, that its suspension products are free from workmanship and material defects for as long as the purchaser owns the vehicle on which the product(s) were originally installed. This warranty will be void if any modifications are made to the components, including alterations to the surface finish, i.e.; painting, powder coating, plating, and/or welding, or if they are improperly installed. Cognito truck suspension products are not designed nor intended to be installed on "competition" vehicles used in race applications, stunt or for exhibition purposes that are outside of the intended operating conditions specified by the manufacturer. Racing and competition are defined as any contests between two or more vehicles; or vehicles competing individually on off road circuits in timed events (whether or not such contests are for an award or prize).

This warranty does not include coverage for police, taxi, government or commercial vehicles, and the warranty does not cover Cognito products sold outside of the USA. Cognito's obligations under this warranty are specified and applied at its sole discretion, and warranty coverage is limited to repair or replacement of the defective product(s). Any and all costs of removal, installation or reinstallation; freight charges, incidental or consequential damages associated with the covered products are expressly excluded from this warranty.

The following items are exempt from Cognito limited warranty coverage: bushings, bump stops, tie-rod ends (Heim joints) and limiting straps. These parts are "consumables" and designed to wear as a normal part of their duty cycle, therefore they are not considered defective when worn. The aforementioned products are warranted separately against defects in workmanship, for 60 days from the date of purchase. As a condition of warranty validation, respective Cognito suspension components must be installed as a complete system (not combined with non-Cognito hardware or ancillary parts). Any substitutions or omission of required components will void the warranty. Some minor cosmetic wear and imperfections may occur to parts during shipping, which is not covered under this warranty. This limited warranty does not apply to any components that have been subjected to collision damage, negligence, alteration, abuse, or misuse, and coverage does not extend to products manufactured by third-party companies. Cognito reserves the right to supersede, discontinue, or change the design, finish, part number and/or application of its parts when deemed necessary, without notice.

Return Policy

Product returns will not be accepted without prior written approval from an authorized Cognito representative. All products being returned must be shipped via trackable, prepaid freight. Returned products are subject to a 25% percent restocking fee. The eligible return period for products purchased directly from Cognito is 30 days from the verified date when the product(s) were originally received by the purchaser.

Product Safety Advisory

The installation of Cognito steering and suspension components will modify your vehicle's original factory equipment and geometry, which may cause it to handle differently than a stock (unaltered) vehicle. Installation of these components is not intended to strengthen nor reinforce the vehicle's frame, nor are they designed to increase rollover protection. It is necessary to periodically inspect all suspension and drive train components for proper attachment, torque specifications, operation, and for any potential unusual wear or damage. Installation of these parts will modify the height of the vehicle and may raise the center of gravity. Modifying vehicle height combined with off road operation may increase your vehicle's susceptibility to rollover conditions, which may cause serious injury or death. Many states regulate allowable vehicle height modifications, and it is your responsibility to know and comply with the legal requirements specified by the laws where you reside. Modifications to your vehicle's ride height may also affect the ride quality, driver input response, trackability and handling, and wear to your vehicle's suspension components and tires.