



34935 Flyover Ct. Bakersfield, CA 93308
Phone: (661) 588-8085 | Fax: (661) 588-8295

INSTALL INSTRUCTIONS:
2019 GM 1500 4", 5", and 6" Lifts



PARTS LIST OVERVIEW

PART #	DESCRIPTION
110-70099	2019 GM 1500 4" Subframe Component Box
110-70100	2019 GM 1500 4" Spindle Component Box
110-70101	2019 GM 1500 4" Diff Component Box
110-70102	2019 GM 1500 4" Strut Spacer Kit (Unless kit includes Coil Overs)

WARNING

Please read this entire instruction sheet before beginning installation. Proper installation of these components requires a qualified mechanic. Always wear safety glasses when using power tools, and take appropriate precautions when working under a vehicle. If these instructions are not properly followed you may jeopardize your, and your passenger's safety, and severe frame, suspension or tire damage may also result from improper installation.

TECHNICAL INFORMATION

- Check the parts and hardware packages against the parts list to assure that your kit is complete.
- Each lift kit, and options to lift kits, are packaged separately. Therefore, installation procedures are covered in separate instructions. Familiarize yourself with each specific set of instructions before beginning.

REQUIREMENTS

- Installation requires a qualified mechanic.
- A lift is required to perform the installation of these products and always ensure the vehicle is properly supported before attempting installation or serious injury may occur.
- Read instructions carefully and study the pictures before attempting installation.

CHOOSING THE RIGHT LIFT

2019 and newer GM 6 lug trucks come from the factory at one of two different heights:

Standard trucks, including the Denali with Adaptive Ride Control, have a rear end that is 1.5" higher than the front, so for a 4" front lift Cognito recommends a 2.5" rear end lift to bring the truck to level. This 2.5" rear lift can be done with either a 2.5" rear block, or a mini-pack spring. The mini-pack spring allows adjustment of the rear end lift height and improves ride quality by replacing the OEM bottom overload spring with a more progressive mini-pack of springs. The mini-pack also includes several spacer blocks to fine tune the rear lift height. To take a standard truck to 6", Cognito recommends either a 4.5" rear block, or a mini-pack spring with a 2.5" rear block.

For a standard truck lifted 4", Cognito recommends the following tire options:

OEM 20" Wheels and 295/60R20 Tires

OEM 22" Wheels and 295/55R20 Tires

Note: with an 18" wheel the max backspacing that can be used is 4.5"

34x12 Tire, 18x9 wheel, max 4.5" backspacing

34x12 Tire, 20x9 wheel, 4.75" backspacing

For a standard truck lifted 6", Cognito recommends the following tire options:

OEM 20" Wheels and 295/65R20 or 35x12.5R20 Tires

OEM 22" Wheels and 295/55R20 or 35x12.5R22 Tires

Note: with an 18" wheel the max backspacing that can be used is 4.5"

34x12 Tire, 18x10 wheel, max 4.5" backspacing

34x12 Tire, 20x10 wheel, 4.75" backspacing

35x12 Tire, 18x10 wheel, max 4.5" backspacing

35x12 Tire, 20x10 wheel, 4.75" backspacing

AT4 and Trailboss models have a factory 2" front and rear lift, which leaves the rear end 1.5" higher than the front. The Cognito 4" front lift for AT4 and Trailboss will be a 4" lift over the originally equipped 2" lift, making the truck as tall as a standard truck equipped with a 6" lift. For an AT4 or Trailboss, Cognito recommends a 4.5" rear block used in place of the stock 2" block, or a mini-pack used with the stock 2" block.

For an AT4 or Trail Boss truck lifted 4", Cognito recommends the following tire options:

OEM 20" Wheels and 295/65R20 or 35x12.5R20 Tires

OEM 22" Wheels and 295/55R20 or 35x12.5R22 Tires

Note: with an 18" wheel the max backspacing that can be used is 4.5"

34x12 Tire, 18x10 wheel, max 4.5" backspacing

34x12 Tire, 20x10 wheel, 4.75" backspacing

35x12 Tire, 18x10 wheel, max 4.5" backspacing

35x12 Tire, 20x10 wheel, 4.75" backspacing

PARTS LIST FOR 110-70099

QTY.	PART #	DESCRIPTION
1	2612	Skid Plate
2	2613	Clip-Nut Bar
1	2629	Rear Brake Line Drop Bracket
2	6456	Rear Bump Stop Spacer
1	8635	Front Crossmember
1	8636	Rear Crossmember
1	8640	Sway Bar Drop Bracket, DRIVER
1	8641	Sway Bar Drop Bracket, PASSENGER
4	HP9256	M18 CAMBOLT HARDWARE KIT
1	HP9257	2019 1/2 TON 4" HARDWARE
1	2797	Passenger Brake Line Drop Bracket
1	2798	Driver Lower Brake Line Drop Bracket
1	2799	Driver Upper Brake Line Drop Bracket
1	HP9291	Cooling line relocation kit

PARTS LIST FOR HP9256

QTY.	PART #	DESCRIPTION
1	HARDWARE-M18-FLATWASHER	M18 Flat Washer
1	HARDWARE-M18X2.5-LOCKNUT	M18-2.5 Hex Nut Top Lock
1	HARDWARE-M18-2.5X150-CAMBOLT	M18 X 150 MM ALIGNMENT BOLT
2	2621	Eccentric Washer, 2019 GMC 1500

PARTS LIST FOR HP9257

QTY.	PART #	DESCRIPTION
6	HARDWARE-15109	3/8-16X1.5 HCS
6	HARDWARE-33082	33082 3/8 SAE F/W
6	HARDWARE-33622	3/8 Lock Washer
8	HARDWARE-63437	63124 12" Black Cable Tie
6	HARDWARE-CLIP-NUT-3/8-16	3/8-16 Clip Nut
4	HARDWARE-M10-1.5X25-FB	M10 x 1.5 mm Thread, 25 mm Long
4	HARDWARE-M10-F/W	M10 FLAT Washer
4	HARDWARE-M10X1.5-FN	M10 - 1.5 Flange Nut Nylon Insert
2	HARDWARE-M10X1.5X65	M10-1.5 X 65mm Socket Head Cap Screw
8	HARDWARE-M18-FLATWASHER	M18 Flat Washer
4	HARDWARE-M18X2.5-LOCKNUT	M18-2.5 Hex Nut Top Lock
4	HARDWARE-M18X2.5X120	M18-2.5 X 120mm Cap Screw
6	HARDWARE-M6-FLNUT	M6 - 1.0 Top Lock Flange Nut
4	HARDWARE-M8-F/W	M8 FLAT Washer
2	HARDWARE-M8X1.25-LN	M8-1.25 Steel Top Lock Nut
2	HARDWARE-M8X1.25X20	M8X1.25 20mm Long Hex Cap Screw
4	HARDWARE-M6-1.0X25-FB	M6X1 25MM Long Hex Flange Screw

PARTS LIST FOR 110-70100

QTY.	PART #	DESCRIPTION
1	8631	Driver Spindle
1	8632	Passenger Spindle
1	HARDWARE-M16X1.5-DIENUT	M16x1.5 Die

PARTS LIST FOR 110-70102

QTY.	PART #	DESCRIPTION
2	8392	Strut Spacer GM 07 6-Lug 4Inch Lift Kit
6	HARDWARE-M10X1.25X30-STUD	M10-1.25 x 30mm Press In Stud
6	HARDWARE-M10X1.25-FN	M10 - 1.25 Flange Nut with Nylon Insert

PARTS LIST FOR 110-70101

QTY.	PART #	DESCRIPTION
1	8638	Right Diff Drop Bracket
1	8639	Left Diff Drop Bracket
1	HP9258	2019 GM 1/2 4" TON DIFF COMPONENT HARDWARE

PARTS LIST FOR HP9258

QTY.	PART #	DESCRIPTION
1	HARDWARE-M12X1.75X30	M12-1.75 X 30mm Cap Screw
2	HARDWARE-M12-FLATWASHER	M12 Flat Washer
1	HARDWARE-M12X1.75-LOCKNUT	Nylon-Insert Locknut M12x1.75
1	HARDWARE-M14X2.0X130	M14-2.0 X 130mm Hex Head Cap Screw
6	HARDWARE-M14-F/W	M14 Flat Washer
3	HARDWARE-M14X2.0-LOCKNUT	M14-2.0 Top Lock Hex Nut
2	HARDWARE-M14X2.0X100	M14-2.0 X 100mm Hex Head Cap Screw

INSTALLATION: FRONT

1. Support the vehicle on a lift or on jack-stands, then remove the wheels and tires.
2. Remove the six bolts shown in figure 2 which secure the factory plastic skid plate with a 13mm socket.

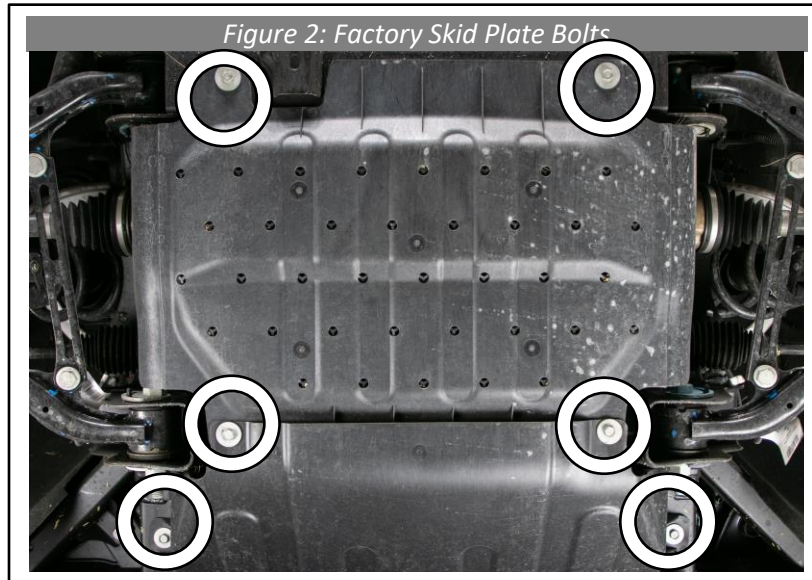

3. Remove the two nuts connecting the sway bar end link to the lower control arm with an 18mm socket. Remove the four bolts attaching the sway bar clamps with a 10mm socket, then remove the sway bar. Retain all hardware for reinstallation. See figure 3.

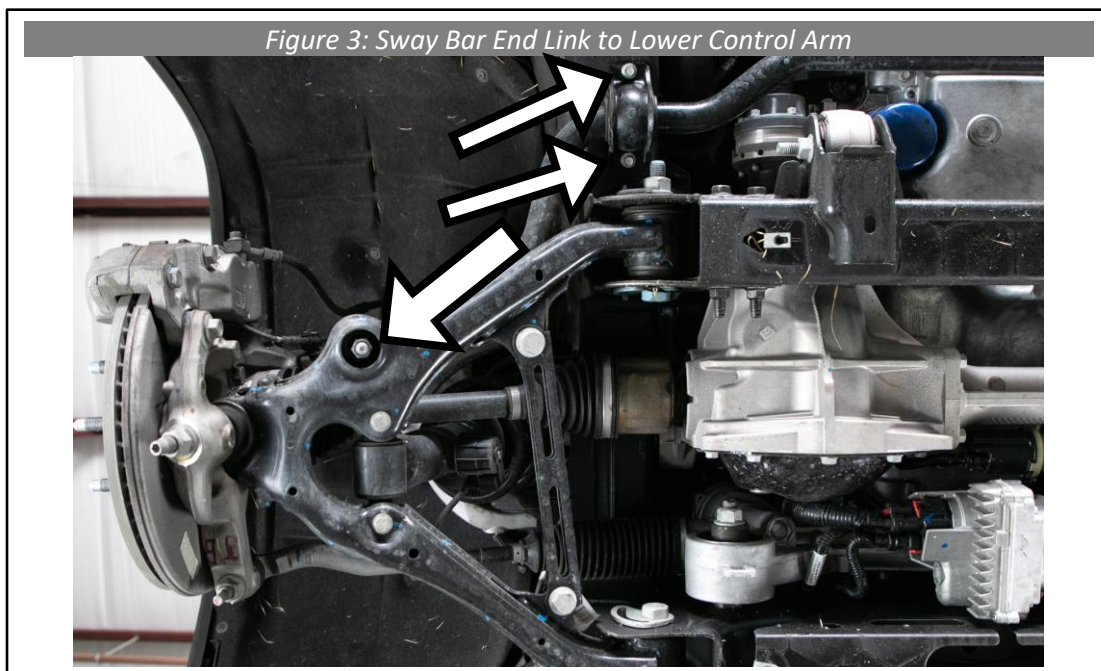

- Remove the 10mm head bolts shown in figures 4a and 4b which hold the wiring, brake lines, and wheel speed sensor to the spindle, then remove the four bolts fastening the brake calipers to the spindle with an 18mm socket. Hang the brake calipers and wheel speed sensors securely out of the way.

Figure 4a: Brake Caliper, Wiring, and Line Hardware

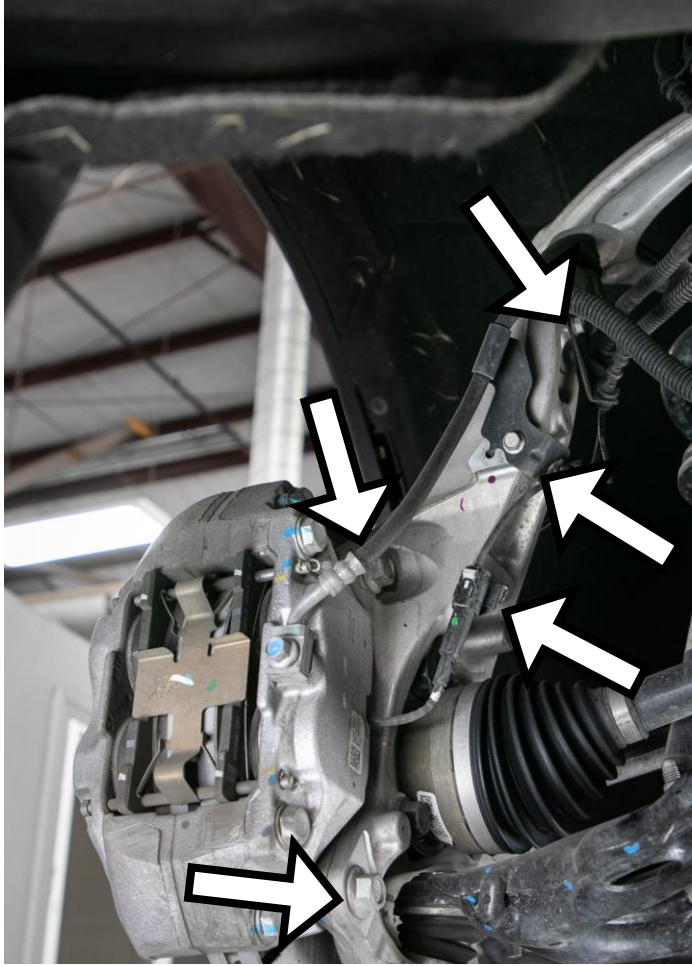
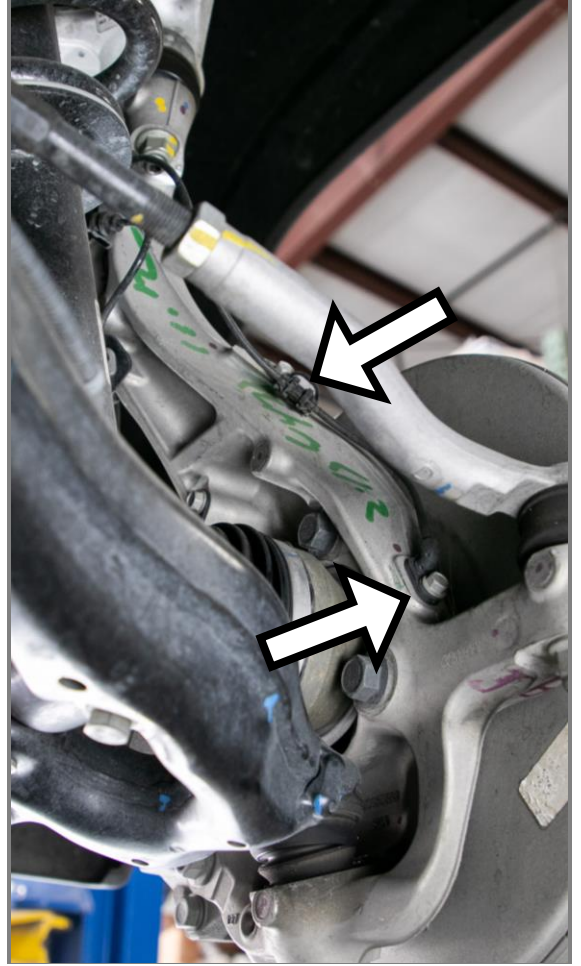

Figure 4b: Wheel Speed Sensor



- Loosen the tie rod end jam nut shown in figure 5a with a 24mm wrench, then remove the tie rod nut with a 21mm socket. Remove the tie rod end from the spindle by striking the spindle with a hammer as shown in figure 5b.

Figure 5a: Tie Rod Nuts

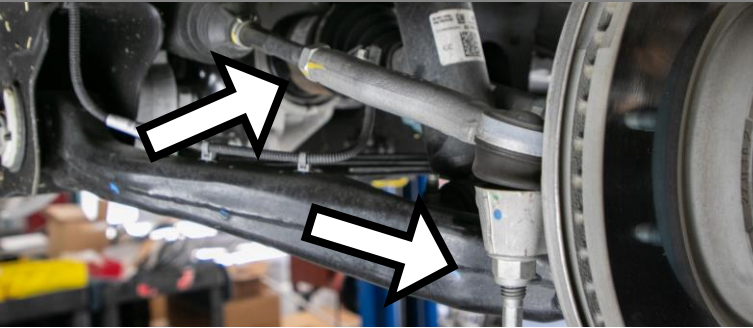
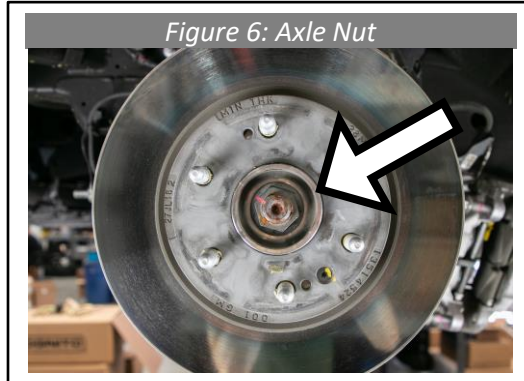

Figure 5b: Strike Spindle



- Remove the axle nuts using a 36mm socket.



- Loosen the lower ball joint nut using a 24mm socket, leave the nut on the lower ball joint stud threaded on, then break the lower ball joint free from the spindle by striking the spindle with a hammer as shown in figure 7.
- Models with Adaptive Ride Control:** Disconnect the shock wiring by sliding the red locking tab back and

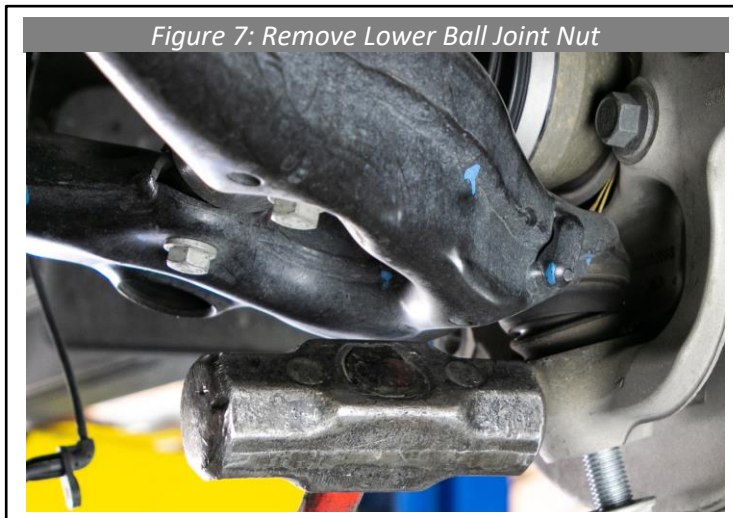

unplugging the connector on the chassis. Slide the tab shown in figure 8b back and disconnect. Remove the wire from the chassis by clipping the zip tie shown in figure 8a and pulling the clips from the control arm. Do not break clips, they will be reused.

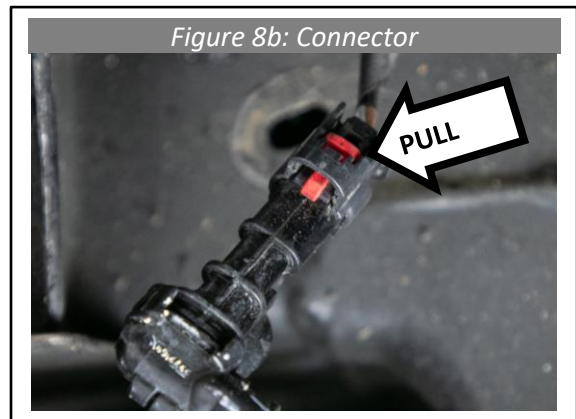
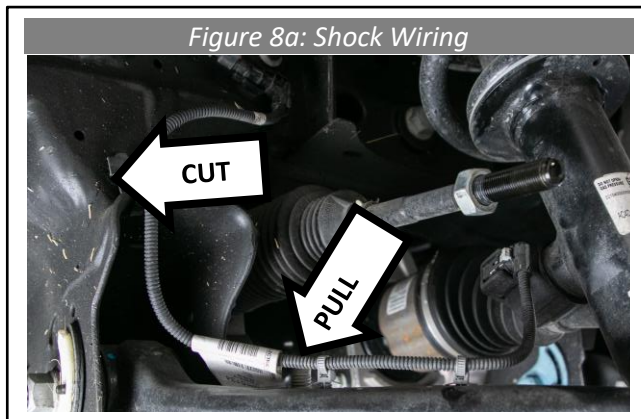

9. Loosen the upper ball joint nut with an 18mm socket or wrench, leave the nut threaded on, then strike the upright on the mark shown in figure 9 to break the ball joint free. Then remove the upper ball joint nut.
10. Allow the spindle to swing down, then remove the axle. Pry between the differential housing and the output cup

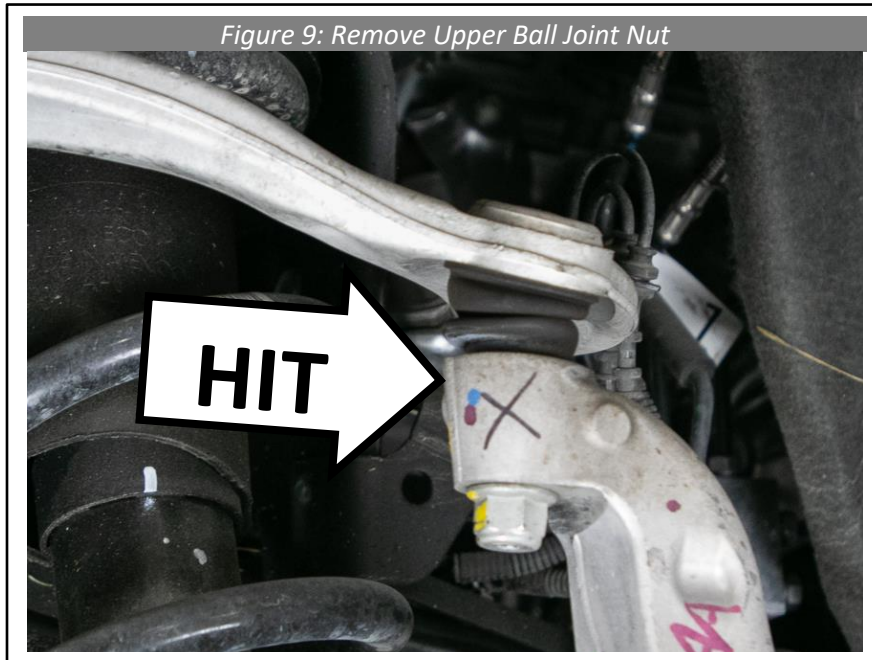

as shown in figure 10 to pop the axle out of the differential.

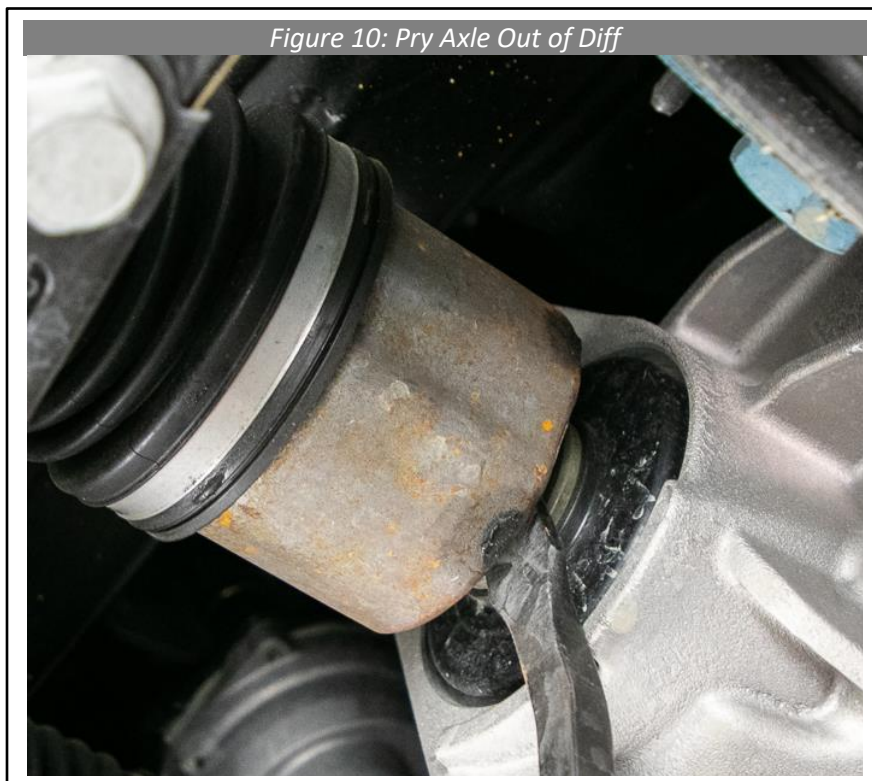

11. Remove the spindle.

12. Remove the 2 bolts shown in figure 12 which connect the shock to the lower control arm with a 15mm socket.
13. Remove the 4 bolts holding the lower arms to the frame with a 27mm socket and wrench. The hardware and

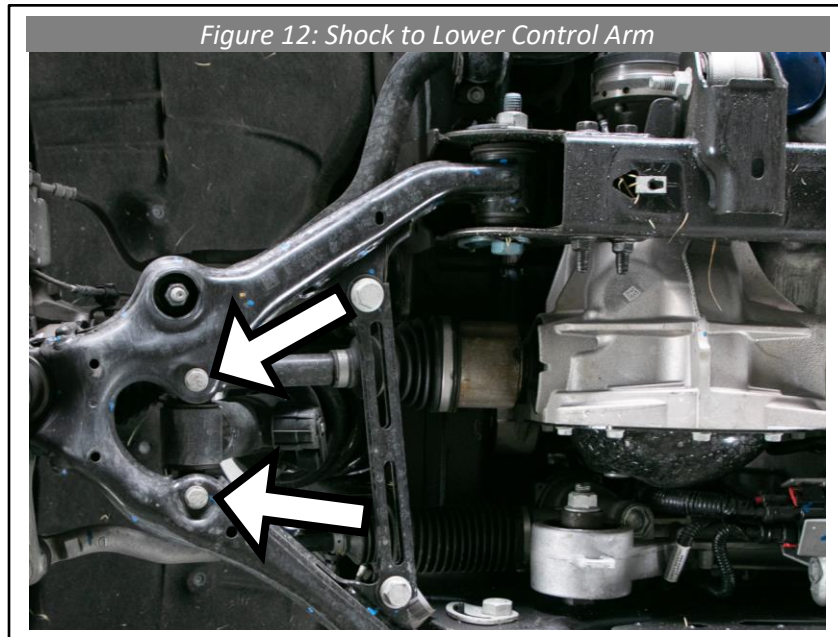

cams can be discarded.

14. The upper shock nuts must be removed with an 18mm wrench. The plastic wire tray above the driver side shock tower must be pried up to allow access, see figure 14. The inner nut on the passenger side is most easily accessed through the engine bay by opening the hood.

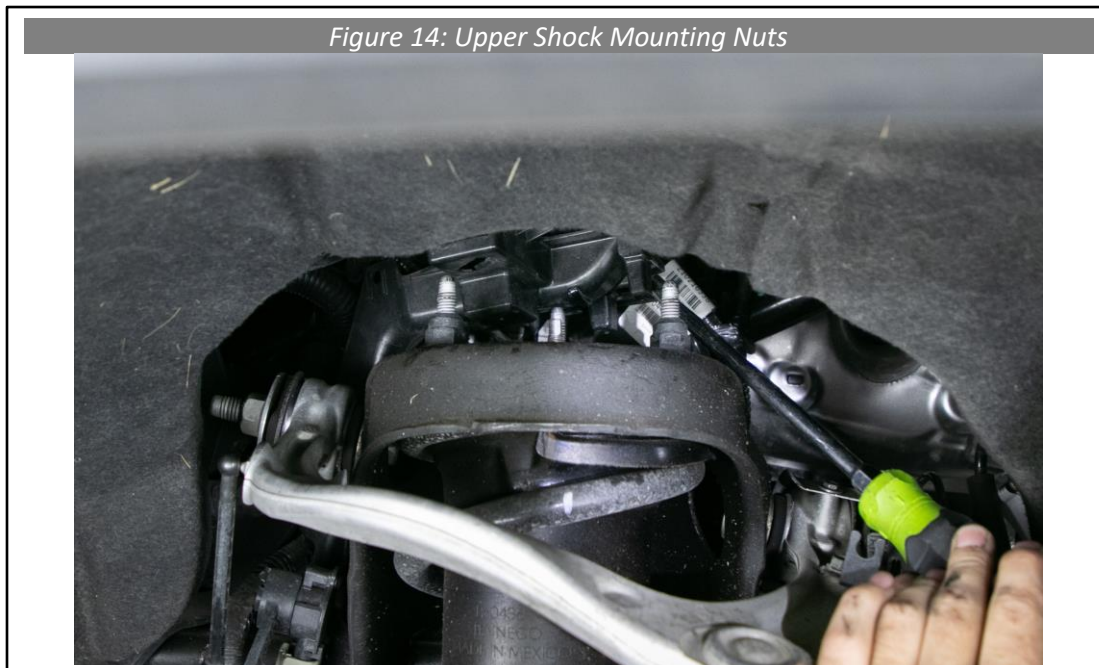

15. Remove the four 18mm head bolts holding the factory rear crossmember in place and the 21mm head rear differential mount. Remove the rear crossmember.

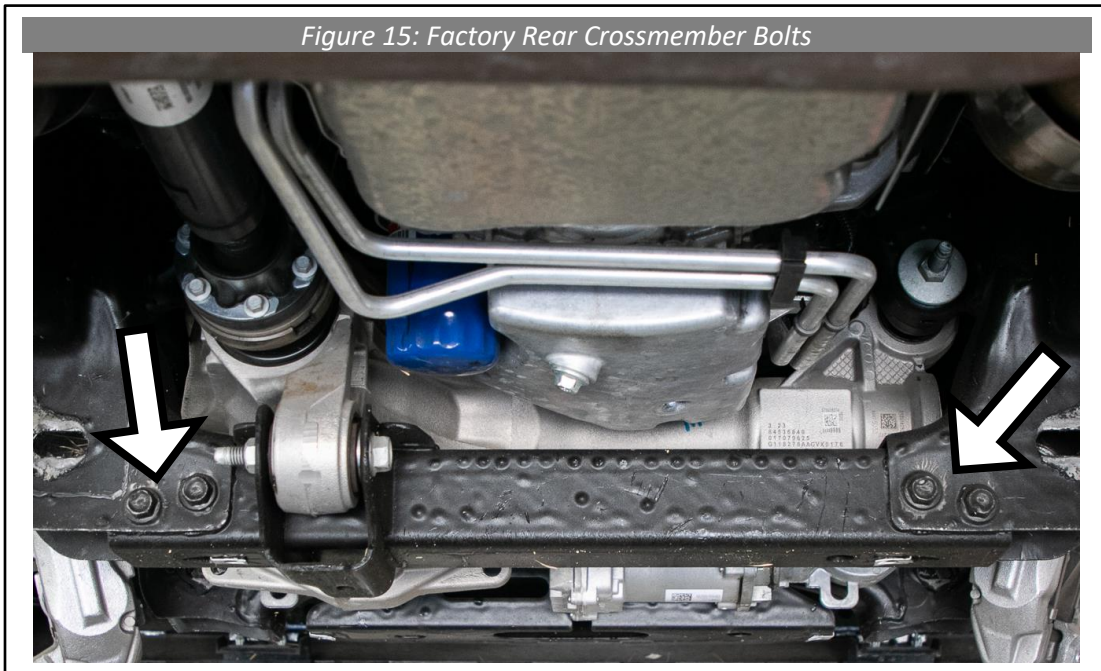

16. **4WD ONLY:** Cut the rear driver's side crossmember as shown below. The cut should go vertically through the middle of the outer bolt hole.



17. **4WD ONLY:** In front of the right upper diff mount there is an electric water pump which prevents the diff mounting bolt from being removed. Remove the 13mm head bolt holding the water pump shown in figure 17.

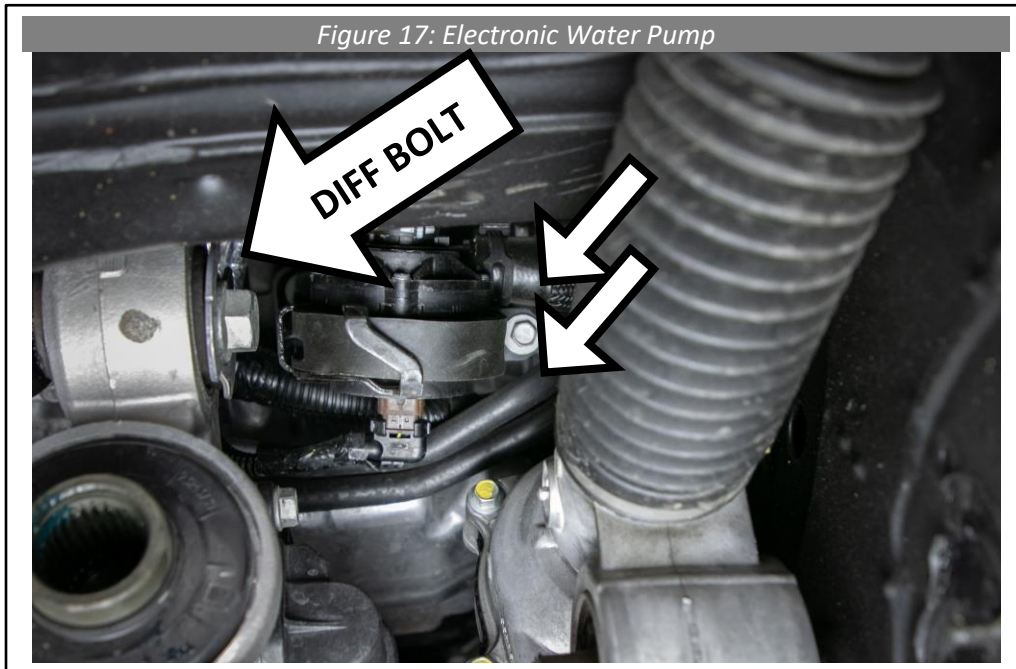

18. **4WD ONLY:** Support the differential on a transmission jack or similar, then remove the 21mm head bolts holding the differential to the chassis. See figures 17 and 18.

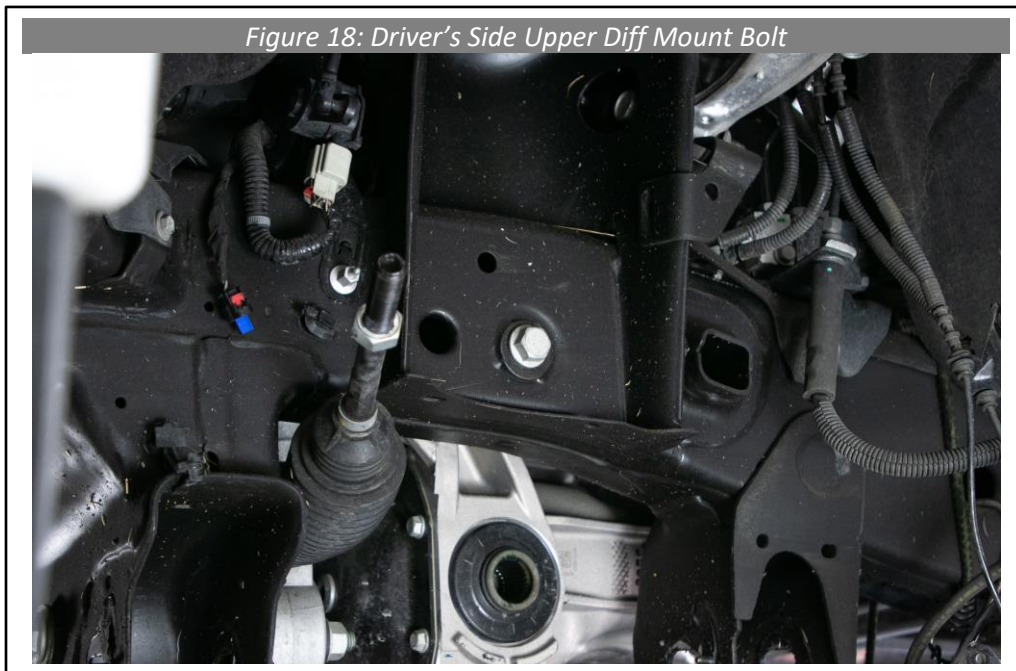

19. **4WD ONLY:** Reinstall the 13mm head bolt holding the water pump from step 17.
20. **4WD ONLY:** Remove the six 10mm head bolts shown in figure 20 which secure the driveshaft to the differential. Move the driveshaft out of the way of the diff.

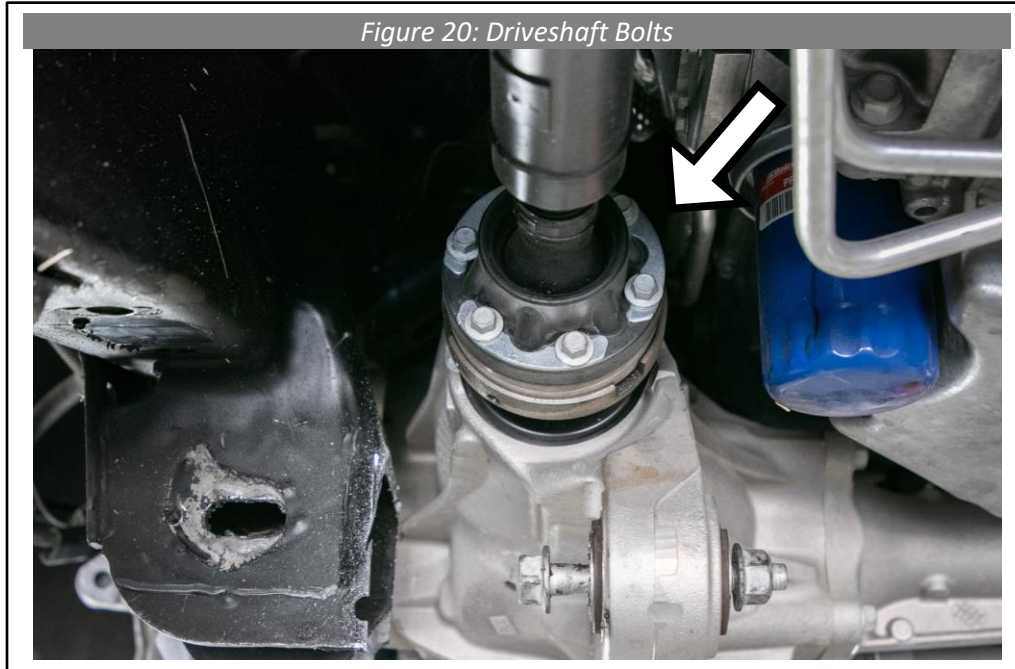

21. **4WD ONLY:** Unplug the wiring to the differential shown in figure 21 by sliding the red tab back and then pulling the connector off.

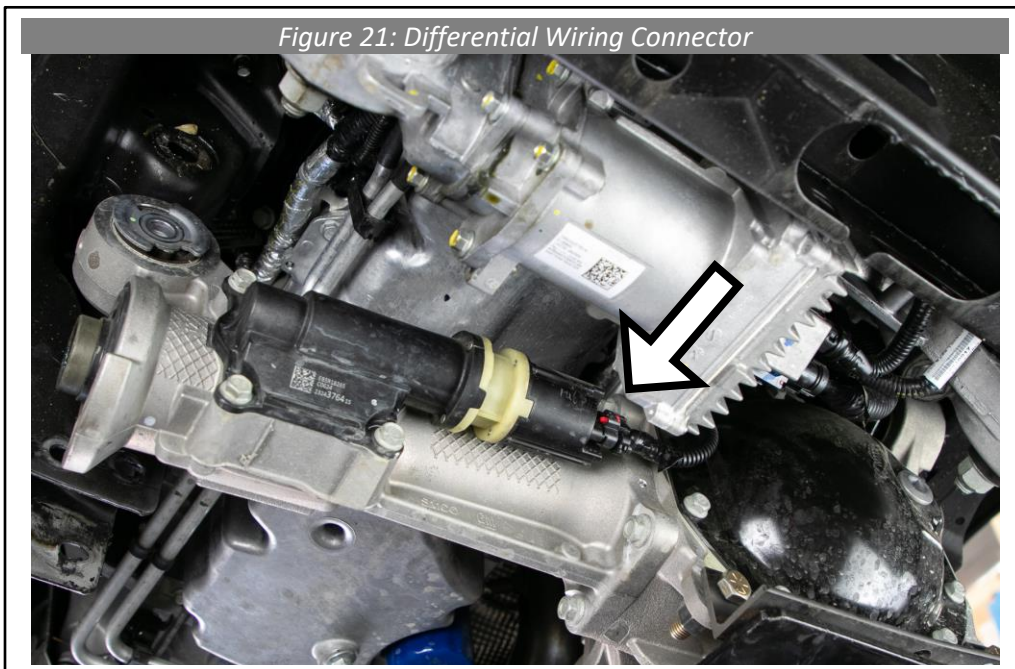

22. **4WD ONLY:** Lower the differential 4". Since it is usually difficult to remove the front differential vent line, cut the vent line as close to the differential as possible. Snip the two zip-ties shown in figure 22 which hold the wiring harness to the differential cover.

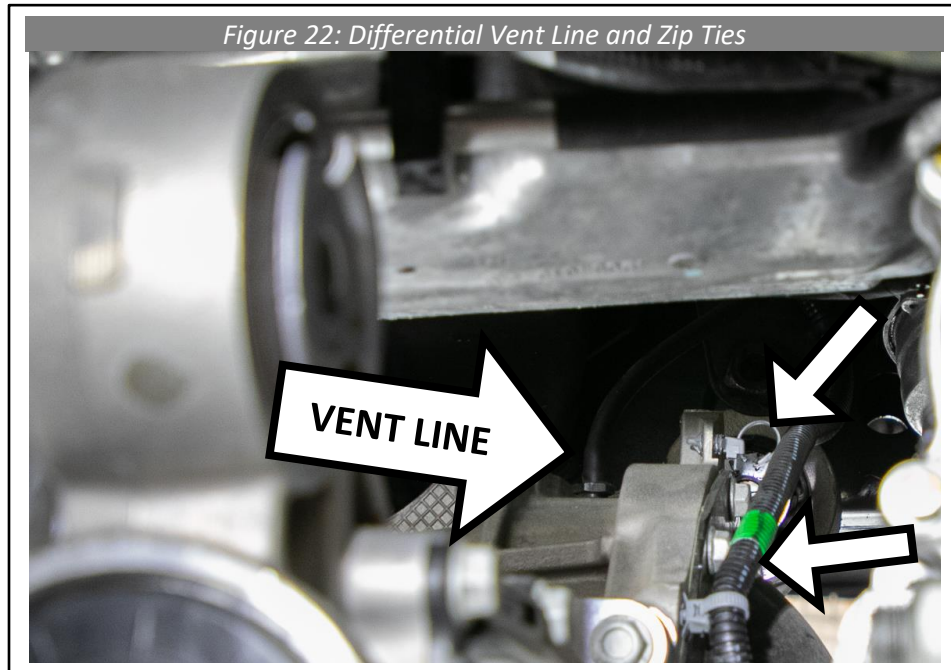

23. **4WD ONLY:** Remove the differential from the truck.

24. Trim the crossmembers as shown in figures 24 below. Optional: Paint cut edges and unwaxed areas with black paint.

Figure 24a: Driver's Side Rear Crossmember, Only Trim Front Face

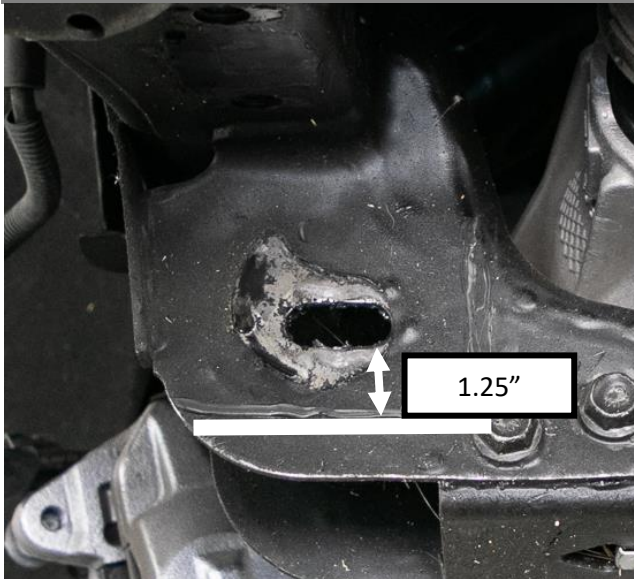

Figure 24b: Passenger's Side Rear Crossmember, Only Trim Front Face

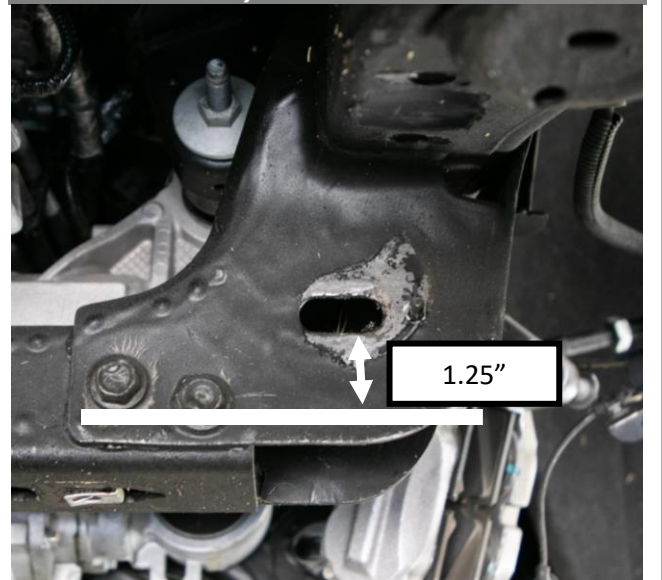

Figure 24c: Driver's Side Front Crossmember, Only Trim Front Face

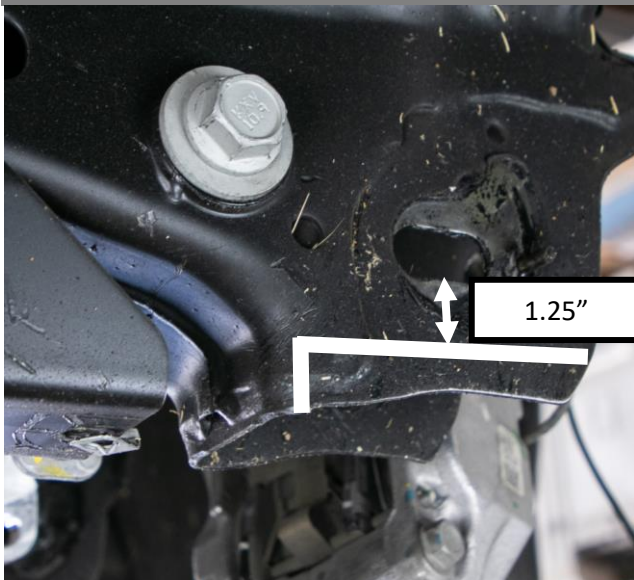

Figure 24d: Passenger's Side Rear Crossmember, Only Trim Front Face

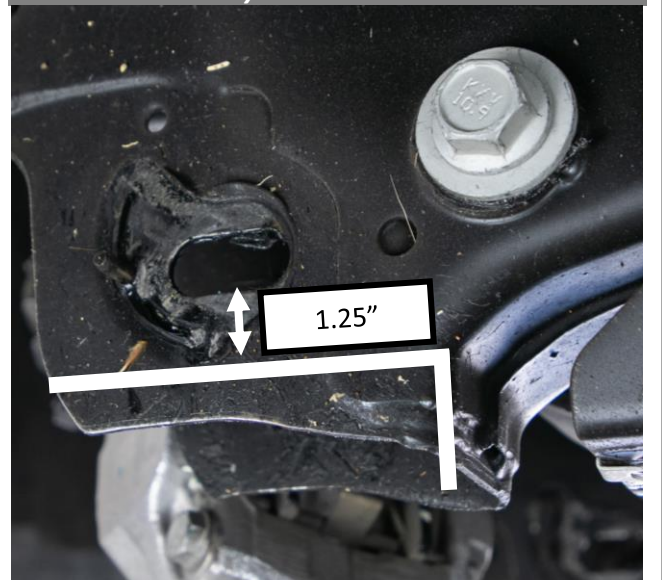

Figure 24e: Driver's Side Rear Crossmember, After Trimming



Figure 24f: Passenger's Side Rear Crossmember, After Trimming



Figure 24g: Driver's Side Front Crossmember, After Trimming



Figure 24h: Passenger's Side Rear Crossmember, After Trimming



25. **4WD ONLY:** Install the right diff drop bracket shown in figure 25 using the M14x2.0x130mm bolt, two M14 flat washers, and an M14 lock nut from HP9258. Do not tighten at this time.

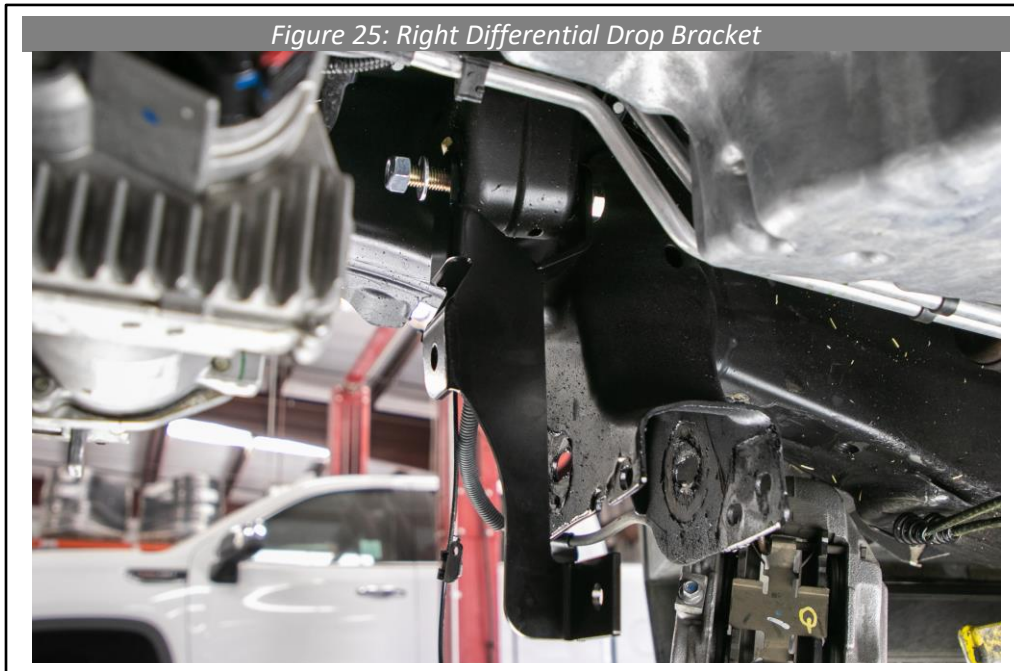

26. **4WD ONLY:** Install the left diff drop bracket shown in figure 26 using the factory bolt but do not tighten.

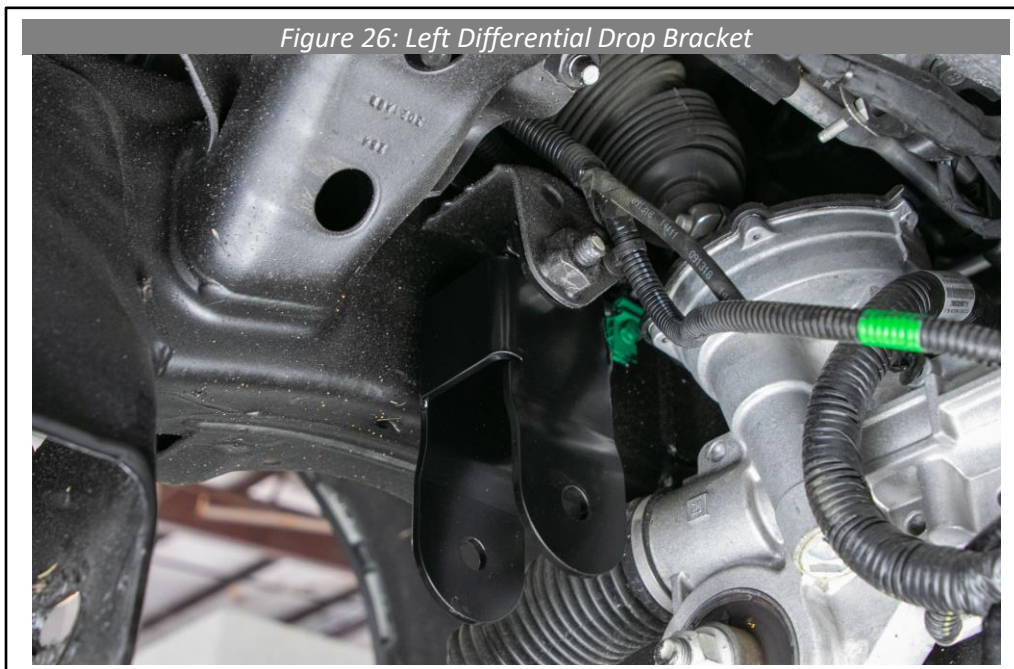

27. **4WD ONLY:** Raise the differential back up into the truck and reconnect the vent line. Attach the diff to the right and left diff drop brackets with the M14x2.0x100mm bolts, washers, and lock nuts included in HP9258.
28. Install the rear crossmember into the frame using two M18x2.5x120mm bolts, flat washers, and lock nuts from HP9257. Tighten to 225 Ft.-lbs. (306 Nm). See figure 29.

29. **4WD ONLY:** Attach the differential to the rear crossmember with the factory bolt, tighten to 105 Ft.-lbs. (143 Nm). See figure 29.

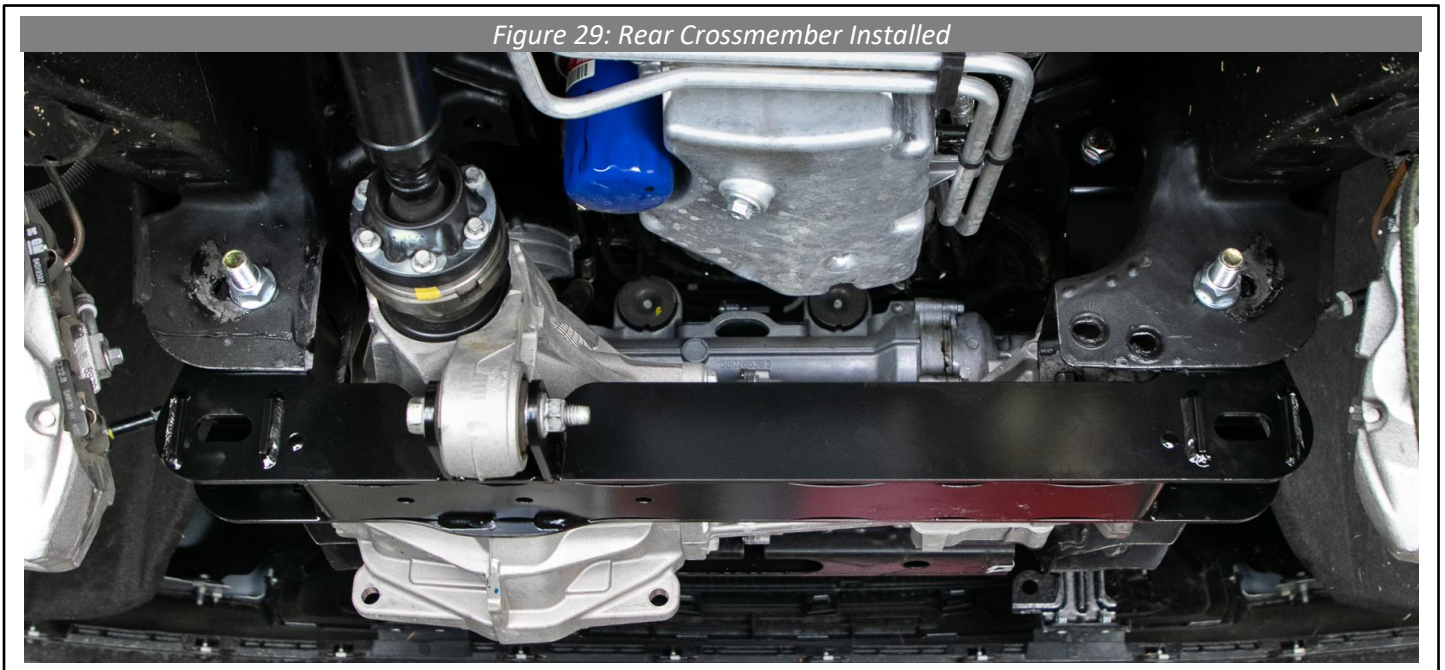

30. **4WD ONLY:** Install the M12x1.75x30mm bolt, washers, and lock nut connecting the right diff mount to the rear crossmember. Tighten to 69 Ft.-lbs. (94 Nm).
31. **4WD ONLY:** Push the differential up using the transmission jack to remove the slop in the factory oversized holes, then tighten all 4 diff mount fasteners to 105 Ft.-lbs. (143 Nm). The transmission jack can now be removed.
32. **4WD Duramax ONLY:** Locate HP9291 and install the supplied Cooling Line Relocation Bracket and hardware. This will drop the cooling lines away from the front driveline. See figure below.

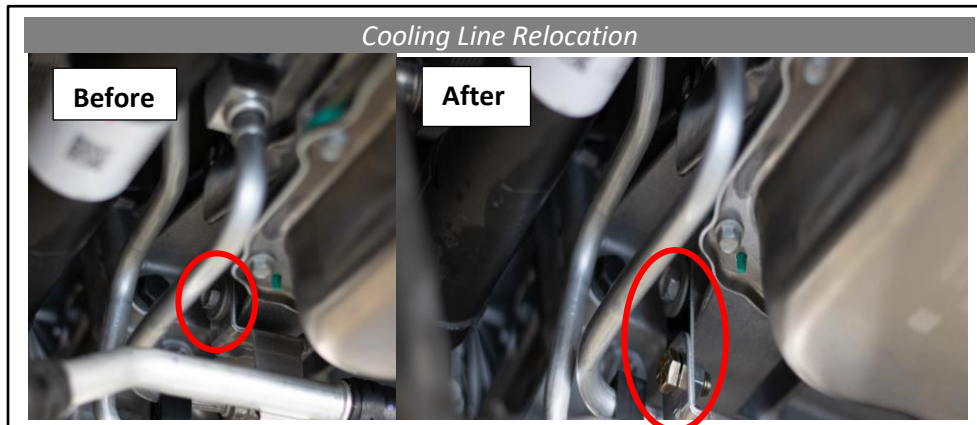

33. **4WD ONLY:** Plug in the differential wiring shown in figure 32 below.

Figure 32: Rear Crossmember Installed

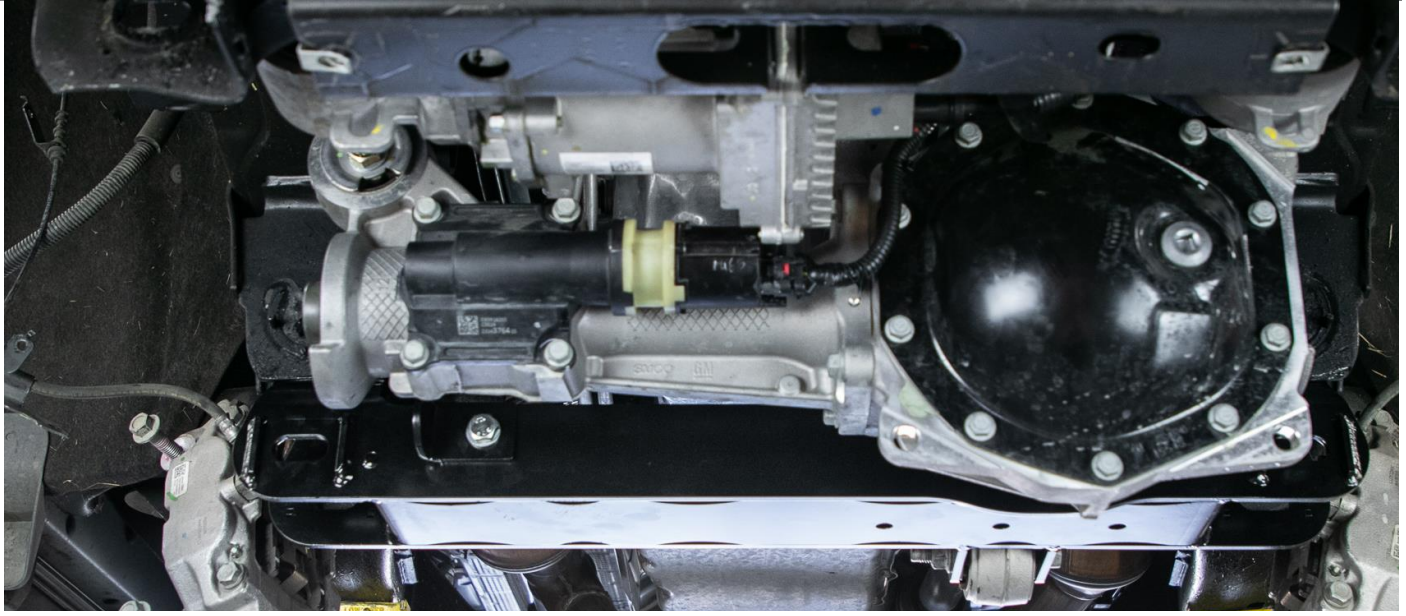

34. Install the OEM front skidplate using 4 of the bolts removed during step 2.

Figure 33: OEM Front Skidplate Reinstalled



35. Install the 3/8-16 clip nuts onto the clip nut bar. Then place into the channel of the front crossmember with the flat side of the nut facing down. Install two 3/8-16 bolts from HP9257 to keep the clip nut bar in place while installing the front crossmember. See figures 34 and 35.

Figure 34: Clip Nut Bar Assembled



36. Install the front crossmember using two M18x2.5x120mm bolts, flat washers, and lock nuts from HP9257. Tighten to 225 Ft.-lbs. (306 Nm).

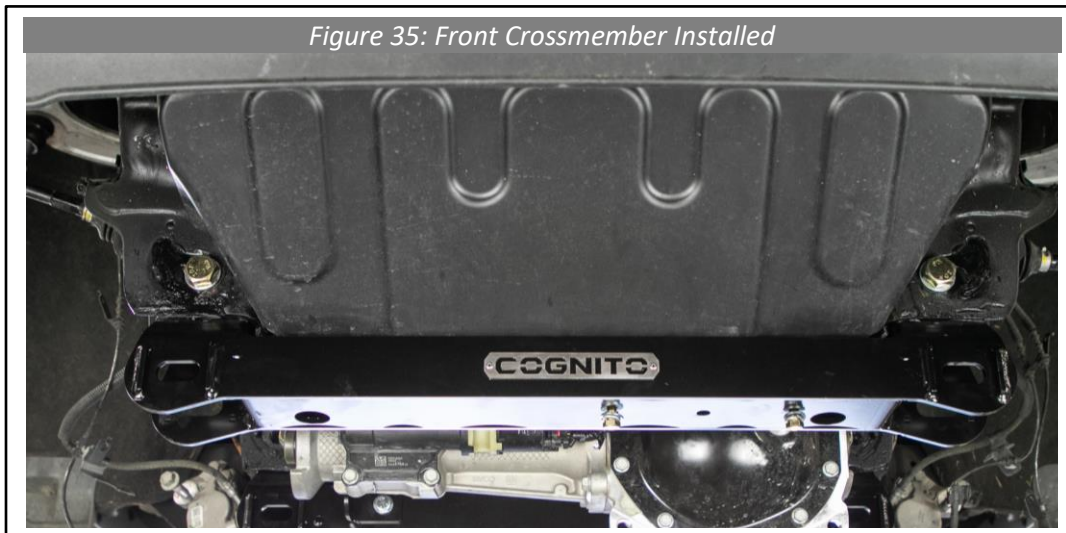

37. Slide the alignment cams onto the M18 D shaped bolts from HP9256 as shown in figure 36. A washer is not used under the bolt head. A press may be needed. 1 cam per bolt.



38. **If you purchased coilovers instead of strut spacers, skip this step, and see shock installation instructions for reservoir bracket installation.** If installing 110-70102 Front Strut Spacer Kit, install the spacers onto the strut tops as shown in figure 37 below and tighten the six M10x1.25 flange nuts to 37 Ft.-lbs. (50 Nm) using a 16mm socket.



39. Install the shock assembly to the chassis. Tighten all 6 nuts to 37 Ft.-lbs. (50 Nm) using an 18mm socket.
40. Install the lower control arm to the crossmember using the eccentric bolts from the front so the thread will be on the back of the crossmember. Place the second eccentric washer on the back side of the crossmember, followed by an M18 washer and M18 lock nut. Do not tighten yet. Both eccentric bolts should face the rear of the vehicle.
41. Attach the shock assembly to the lower control arm with the 4 bolts removed earlier and tighten to 37 Ft.-lbs. (50 Nm). See figure 40.



42. Remove the hub assembly from the factory spindle by loosening the four 18mm bolts. Transfer the O-ring from the factory spindle to the Cognito spindle, it can be gently pried from its groove with a flat-bladed screwdriver. Then install the hub assembly and dust shield into the Cognito spindle and tighten the 4 bolts to 133 Ft.-lbs. (181 Nm). See figures 41 below.

Figure 41a: Hub Installed in Stock Spindle



Figure 41b: Removing O-ring from Stock Spindle



Figure 41c: Installing O-ring in Cognito Spindle



Figure 41d: Hub Installed in Cognito Spindle



43. Make sure the three tapered holes in each spindle, for the upper and lower ball joints and the tie rod, are free from debris or powdercoat. Then install the spindle to the lower arm using the factory nut, tightening to 161 Ft.-lbs. (219 Nm) with a 24mm socket.
44. **4WD ONLY:** Lubricate axle splines with anti-seize. Swing the spindle down, then install the axle to the hub, then swing the axle up and install to the differential as shown in figure 43. Installing the axle into the differential can require significant force, ensure that the retention clip has fully seated into the differential by pulling back on the inner joint to make sure the cup is in place.

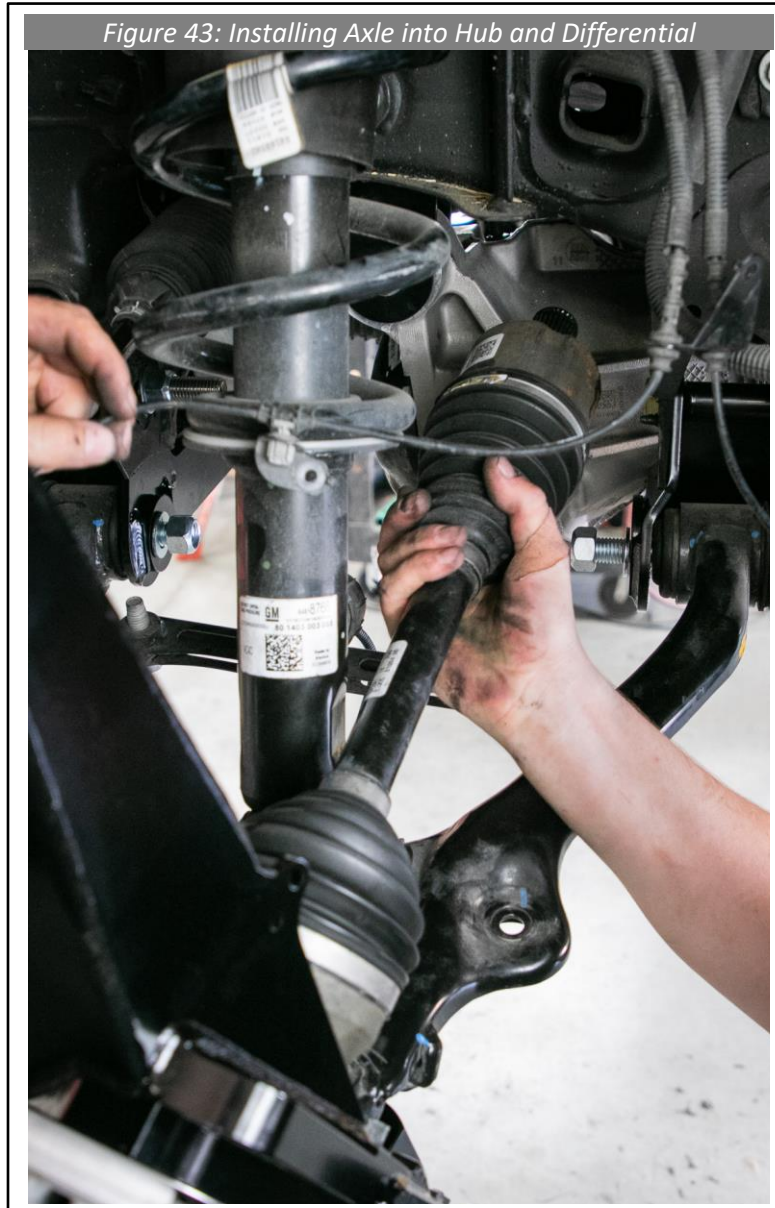

45. Attach the upper control arm to the spindle, tighten the nut to 72 Ft.-lbs. (98 Nm) using an 18mm socket.
46. **4WD ONLY:** Tighten the axle nut to 188 Ft.-lbs. (306 Nm) using a 36mm socket.

47. Remove the OEM outer tie rod end. Since the outer tie rod end is too long, we need to add threads to the inner tie rod end and shorten the outer tie rod end. Apply tapping fluid or WD-40 to the M16x1.5 die and then thread onto the OEM inner tie rod with the tapered end of the die going on first. Using a 16mm wrench to hold the inner tie rod and a 1 1/4" wrench to hold the die, thread the die on until the end of the die is just under 1 3/4" away from the shoulder on the tie rod. See figures 46a and 46b. Do not remove the die before using an angle grinder or hacksaw to cut the tie rod end just behind the die. After cutting you can use a 1 1/4" socket on a ratchet or impact driver to thread the die on up to the shoulder. If using an impact driver set it to a low setting and use plenty of cutting fluid or WD-40. Lastly, you need to cut the outer tie rod end at the ridge shown in figure 46c. Before installing the outer tie rod end onto the inner tie rod end be sure to clean both threads thoroughly. **In order to clear the strut, you will need to install the right side tie rod on the left side of the car, and vice versa, so the curve in the tie rod end goes forward.** See figure 46D. Reinstall the jam nut and install the outer tie rod end before installing into the spindle and tightening to 69 Ft.-lbs. (94 Nm)

Figure 46a: Thread Die On To Tie Rod End



Figure 46b: Measure Position of Die



Figure 46c: Cut Outer Tie Rod End



Figure 46d: Tie Rod End Installed (Driver's Side Shown)



48. Install the brake calipers onto the spindles, making sure the caliper has not been twisted which will bend the brake line, and tighten the bolts to 150 Ft.-lbs. (204 Nm) using an 18mm socket.
49. Remove the metal brackets shown in figures 48a and 48b. For figure 48b, cut through the grey plastic clips.

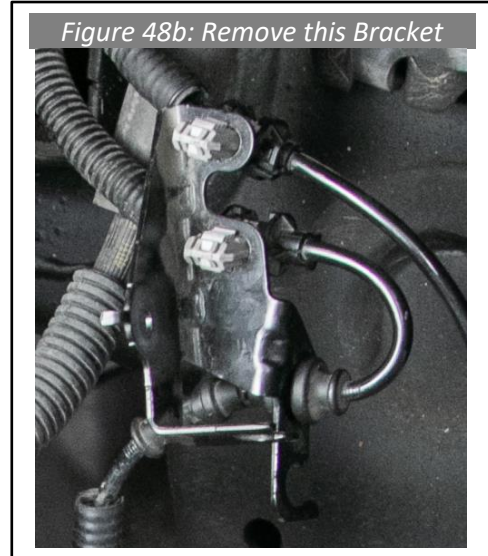

Note: The design of the OEM brake lines changed between the 2019 and 2020 model years. For 2019 model year vehicles, follow step 49a, for 2020 and later follow step 49b.

50. A: 2019 model year

Attach the brake line bracket to the spindle using the M6x1x25mm bolts, washer, and lock nuts included in HP9257. Tighten to 13 Ft.-lbs. (18 Nm) with a 10mm socket. See figure 51b.

B: 2020 and later model years

There are three required brackets included with the kit, shown in figure 49a. Bracket A is installed on the driver's side frame rail where the hard line transitions to rubber. Remove the clip holding the brake line to the factory bracket and pull the brake line down. Remove the bolt holding the factory bracket with a 13mm socket, install bracket A on top of the factory bracket as shown in figure 49b, and tighten the bolt. Reinstall the clip which will now hold the factory brake line to bracket A as shown in figure 49b.

Bracket B attaches to the driver's spindle as shown in figure 49c, where the bracket on the factory brake line bolts to it. The brackets on the factory brake line can be moved, be careful not to damage the rubber hose, use WD40 to make the bracket slide more easily. Use the included M6 flange bolts and washers. Tighten to 13 Ft.-lbs. (18 Nm) with a 10mm socket.

Bracket C attaches to the passenger spindle as shown in figure 49d, and the factory brake line bracket bolts to it. Use the included M6 flange bolts and washers. Tighten to 13 Ft.-lbs. (18 Nm) with a 10mm socket.

Figure 49a: Brake Line Brackets A, B, and C

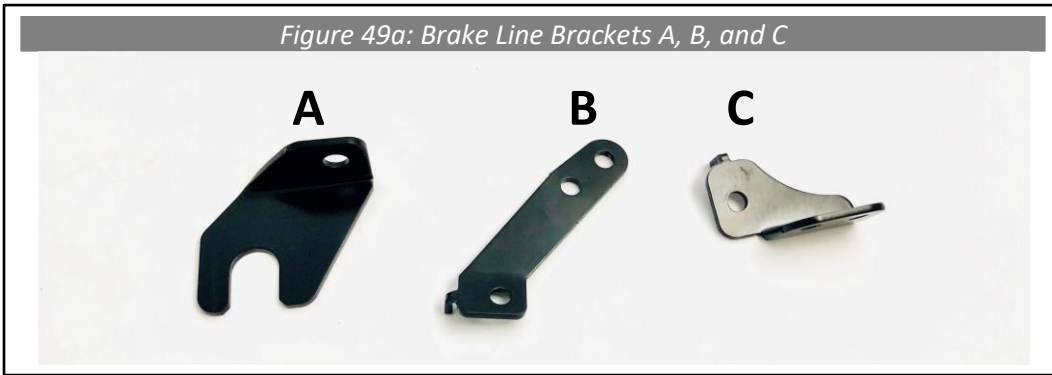

Figure 49b: Bracket A Installed onto Driver Side Frame Rail

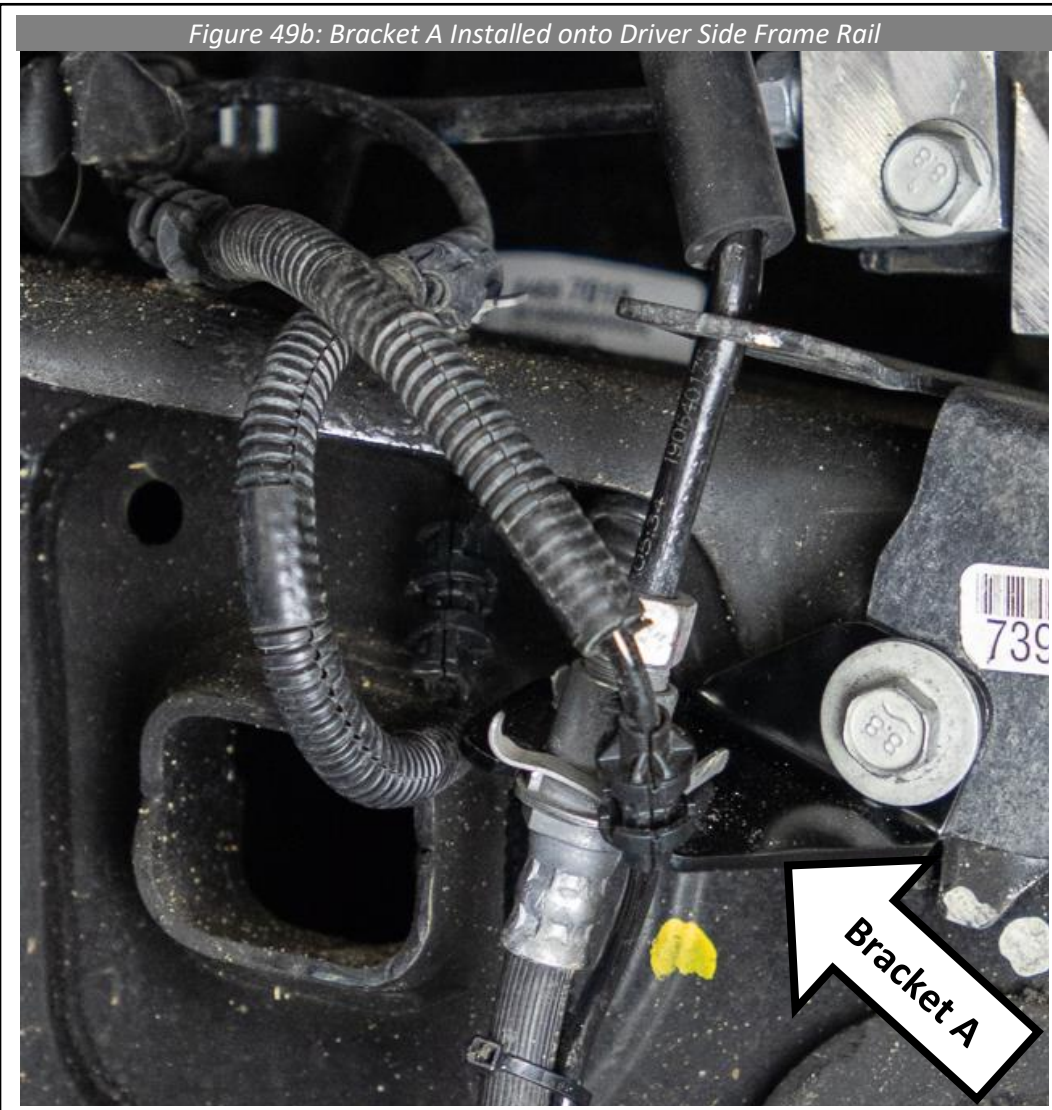

Figure 49c: Bracket B Installed onto Driver Spindle

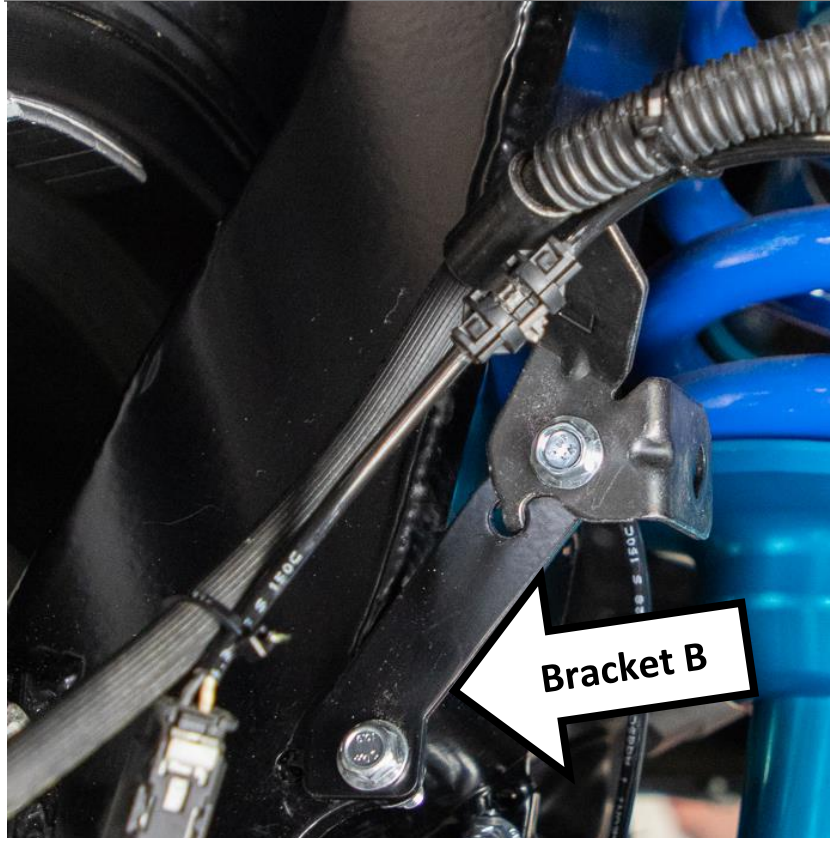
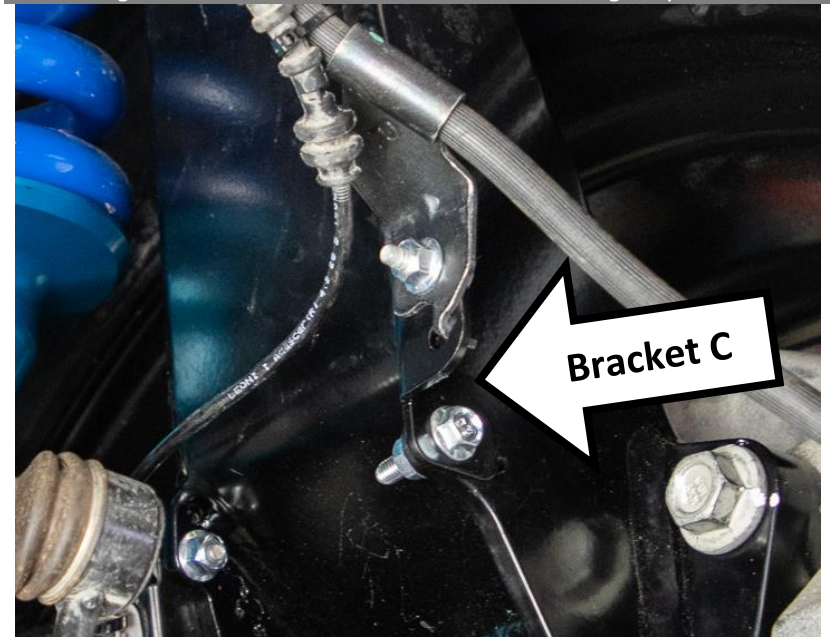

Figure 49d: Bracket C Installed onto Passenger Spindle



51. Install the wheel speed sensor to the spindle and attach the metal bracket holding the sensor wire using one of the 10mm bolts removed from the factory spindle, a washer, and a locknut. Tighten to 13 Ft.-lbs. (18 Nm) with a 10mm socket. See figure 51a.
52. Use the included cable ties to attach the wheel speed sensor and brake pad wear sensor wires to the brake line as shown in figure 51b.

For 2020 and later models: From the factory, the brake pad wear sensor clips onto the brake line bracket now attached to the driver's spindle via bracket B from step 49. Cut the grey plastic clip off and attach the wire to the brake line with zip-ties. See figure 49C. There are several metal clips which can be removed from the factory wheel speed sensor wires, see figures below for detail.

*Figure 51a: Wheel Speed Sensor Installed
(2019 model shown)*



*Figure 51b: Wires Cable-Tied Together
(2019 model shown)*



Figure 51a: Wire Routing, Driver Side
(2020 model shown)



Figure 51b: Wire Routing, Passenger Side
(2020 model shown)

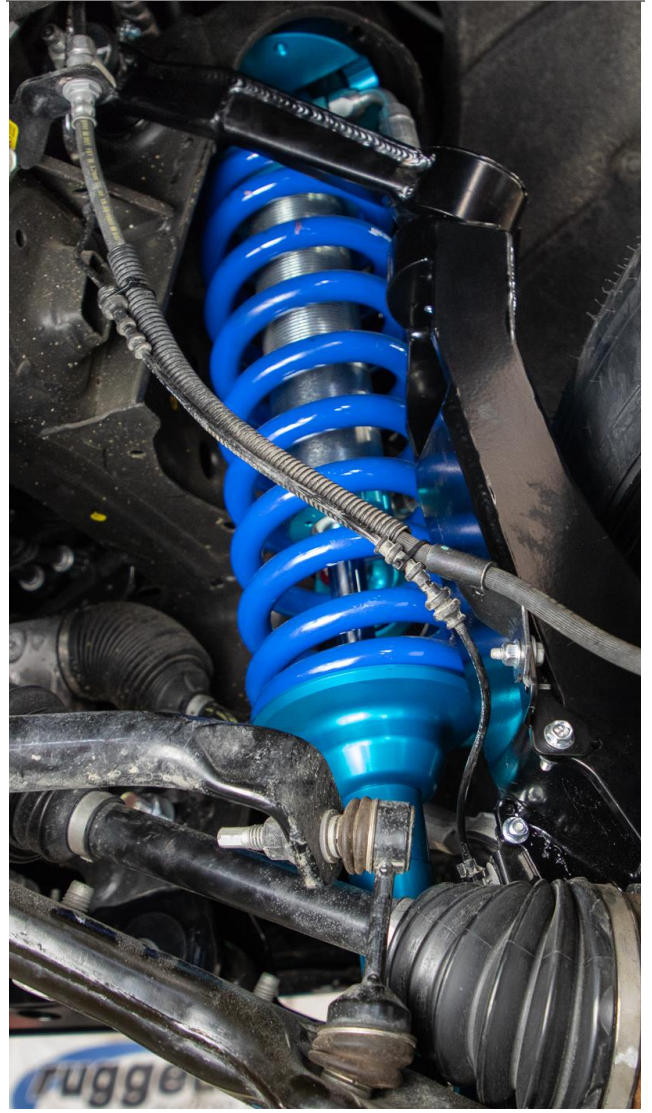

53. **Models with Adaptive Ride Control:** Use the included zip tie to attach the shock wiring to the chassis and press the plastic clips back into the lower control arm.



54. Install the sway bar drop brackets to the chassis using the factory 10mm bolts, tightening to 38 Ft.-lbs. (52 Nm). The brackets should be oriented as shown in figure 54.
55. Install the sway bar clamps to the sway bar drop brackets using four M10x1.5x25mm flange bolts, washer, and lock nuts. Tighten to 38 Ft.-lbs. (52 Nm).

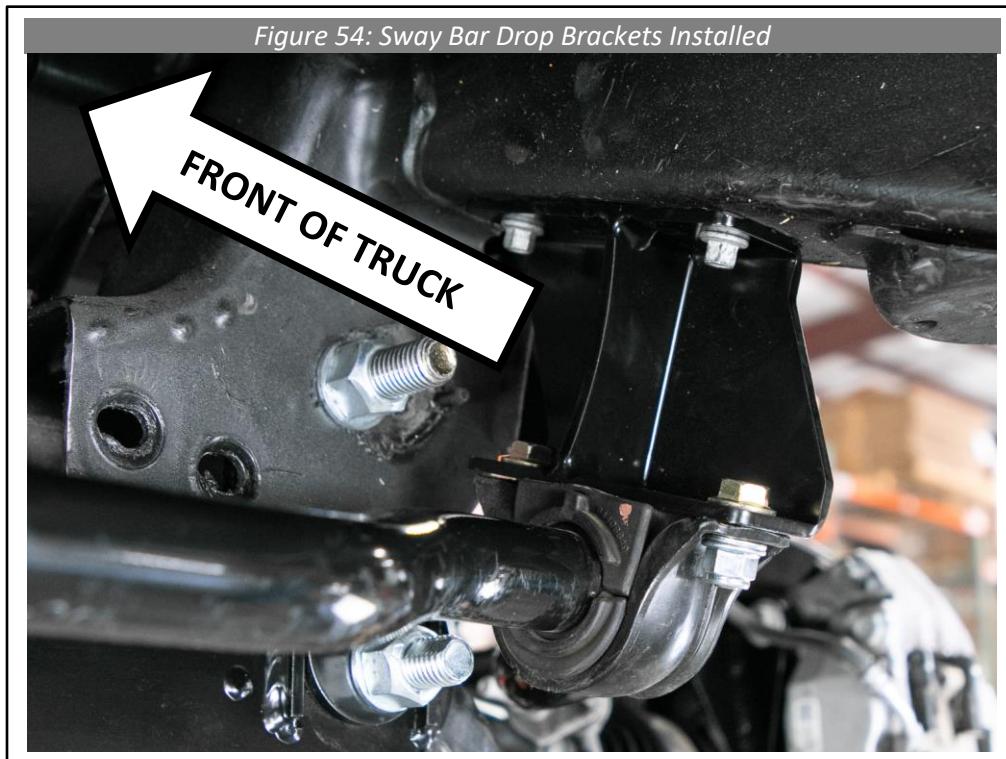

56. Install the sway bar end links to the lower control arm using the factory 18mm head nuts, tighten to 69 Ft.-lbs. (94 Nm).



57. Install the second clip nut bar into the channel of the rear crossmember and align with the skid plate holes.
58. Install the skid plate using the six 3/8-16x1.5 bolts, lock washers, and flat washers. Torque to 35 Ft.-lbs. (48 Nm).

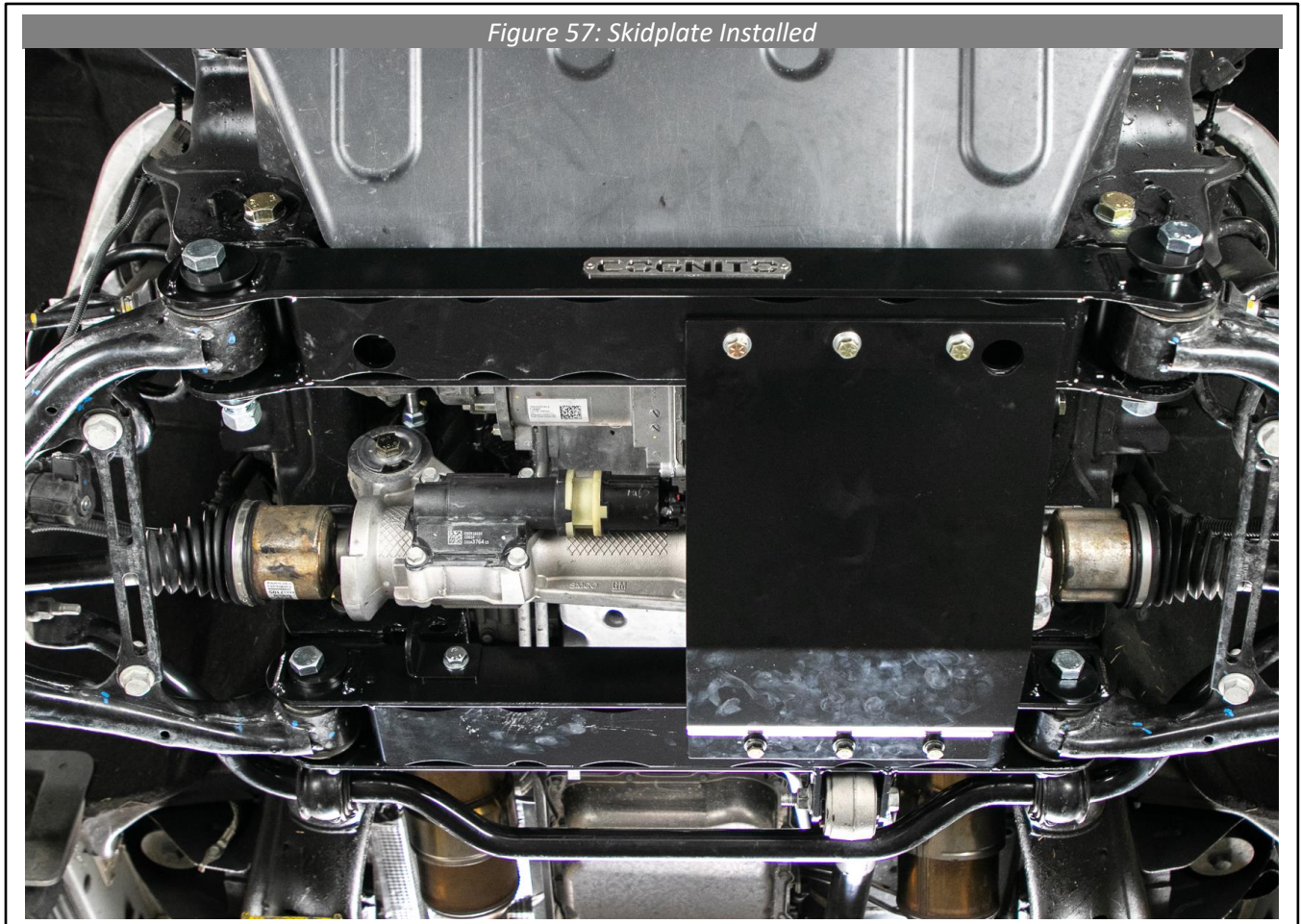

59. Reconnect the front driveshaft to the front differential and torque to 7 Ft.-lbs. (9.5 Nm).

INSTALLATION: REAR

60. With the vehicle in the air, remove the two 13mm head bolts securing the rear brake line bracket. Install the rear brake line drop bracket using the two M8x1.25x30 bolts, washers, and locknuts.



61. Remove the factory bump stop using a 10mm socket. Install the rear bump stop spacer with the M10x1.5 socket head cap screw and lock washer, and tighten to 40 Ft.-lbs. (54 Nm)



If your truck has Adaptive Ride Control, you should have purchased the Adaptive Ride Control Shock Brackets, stop here and consult the instructions which came with that kit. If your truck does not have Adaptive Ride Control, you bought replacement shocks, continue with these instructions.

62. Next, lower the vehicle and set the rear axle onto jack stands. Support the center driveshaft with a jack stand so that the differential does not rotate.

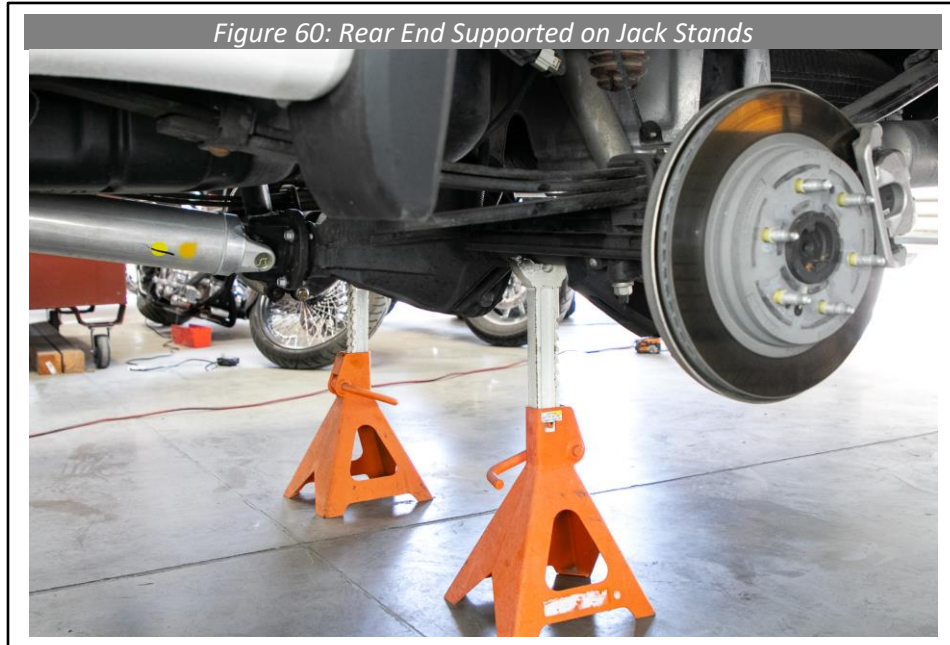

63. Remove the 4 nuts securing the U-bolts with a 21mm socket.

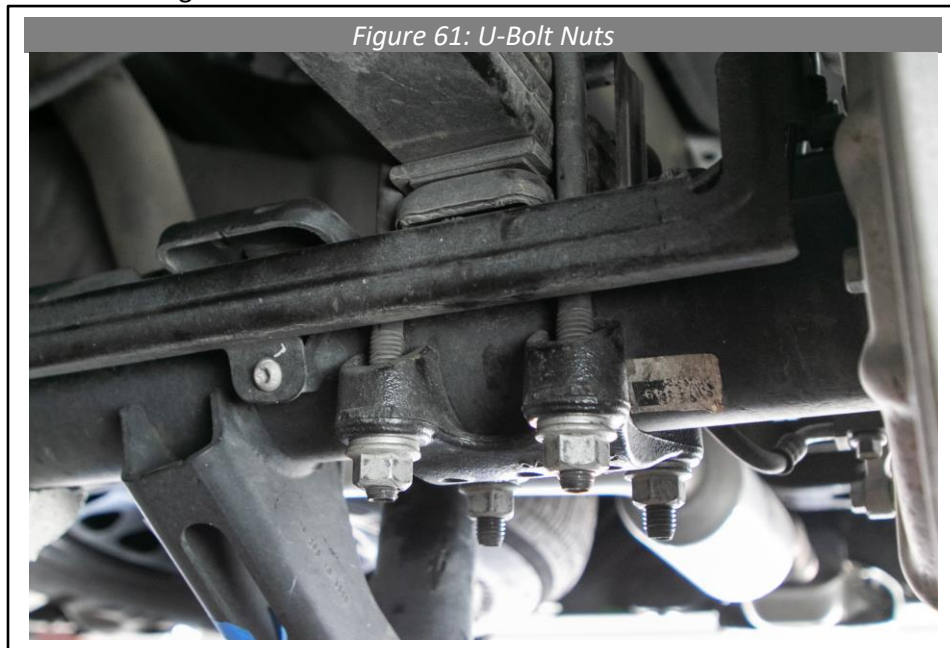

64. Remove the shock bolts with a 21mm socket, remove and discard the factory shocks.

65. Lift the truck 3" so that the leaf spring is no longer touching the top of the axle. **Caution:** Lifting higher than 3" can damage the brake lines and wiring to the rear axle.

If you purchased shocks with remote reservoirs, consult the instructions for that kit on how to mount the reservoirs.

66. Remove the U-bolts and U-bolt plate.

For trucks with a factory 2" block (AT4/Trail Boss), skip the next two steps since your truck does not have a tapered shim.

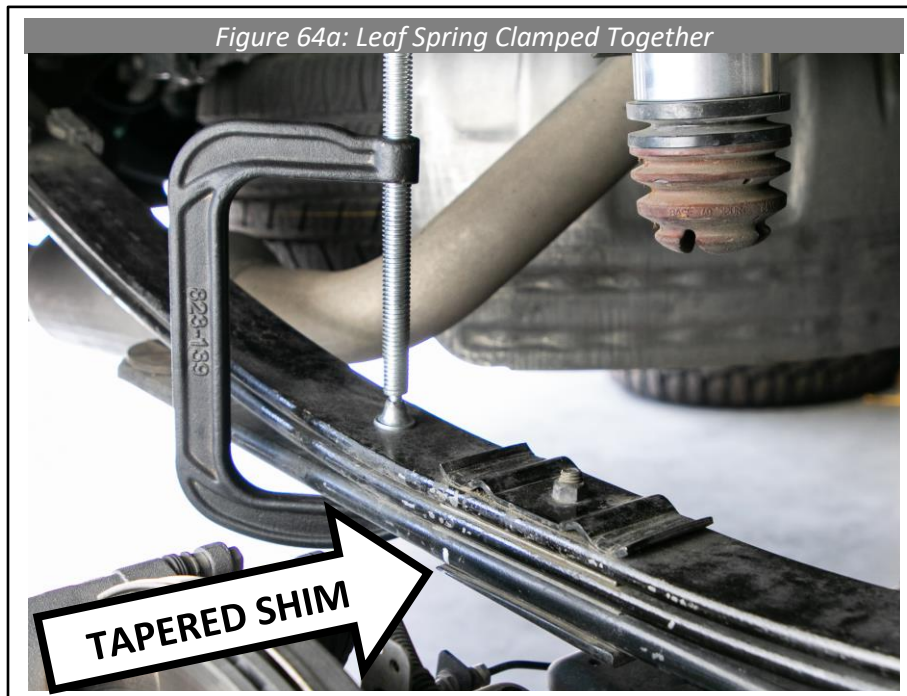

67. Use a c-clamp to hold the leaf spring together, then hold the round head of the center pin with vise-grips. Use a 15mm socket to remove the nut.

68. Remove the tapered shim from underneath the leaf spring and discard. See figure 64a.
69. **If installing mini-packs, perform this step and use the center pin included with the mini-pack.** Reinstall the center pin removed during step 64 and tighten the nut to 69 Ft.-lbs. (94Nm)
70. Next, install the block and/or mini-pack between the axle and leaf spring, and install the U-bolts. Ensure the pins are aligned before tightening the u-bolts, then torque to 100 Ft.-lbs (136 Nm) using a 23mm socket.

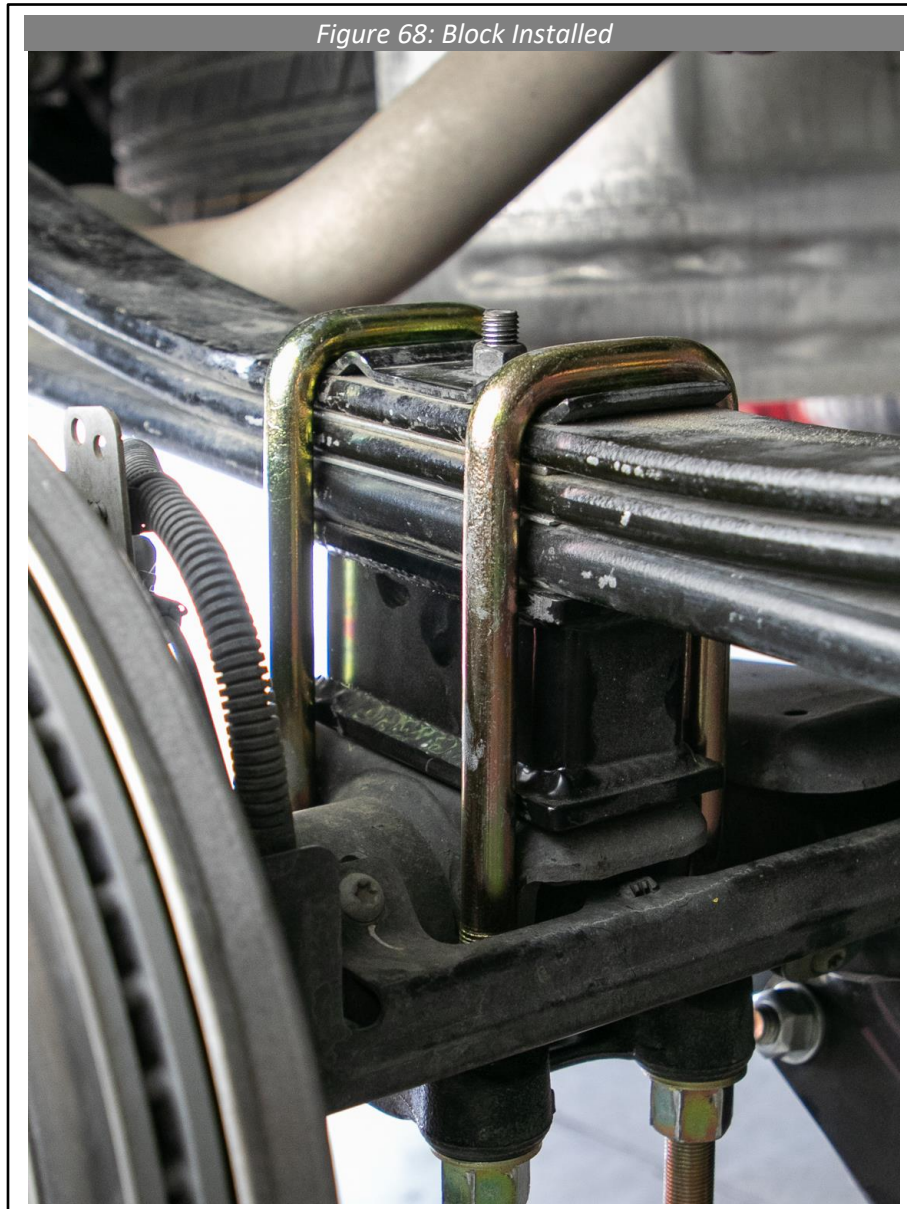

71. Install the new rear dampers and tighten hardware to 85 Ft.-lbs. (116 Nm) using a 21mm socket.

Have the truck professionally aligned to the following specifications:**Caster:** $+3^{\circ} \pm 1^{\circ}$ with 0.8° of cross caster, higher on the passenger side, to account for crowned roads.**Camber:** 0.0° to -0.5° **Toe:** 0.1° in each side**Torque Specs:**

Item	ft.-lbs.	Nm
Arm into Crossmember	225	306
Axle Nut	188	256
Brake Caliper to Spindle	150	204
Brake Line Bracket to Spindle	13	18
Crossmember into Frame	225	306
CV Joint to Diff	42	57
Hub to Spindle	133	181
Left Diff Mount to Diff	105	143
Left Diff Mount to Chassis	105	143
Lower Ball Joint to Spindle	161	219
Rear Brake Line Drop Bracket onto Frame	38	52
Rear Brake Line onto Drop Bracket	19	26
Rear Bump Stop Spacer onto Frame	40	54
Rear Damper Bracket to Axle	105	143
Rear Damper To Bracket	85	116
Right Upper Diff Mount to Crossmember	69	94
Right Upper Diff Mount to Diff	105	143
Right Upper Diff Mount to Frame	105	143
Skid Plate to Crossmembers	35	48
Sway Bar Bracket onto Chassis	38	52
Sway Bar End Links to Lower Control Arm	69	94
Strut Spacer to Frame	37	50
Strut onto Lower Control Arm	37	50
Strut onto Spacer	37	50
Sway Bar onto Sway Bar Bracket	38	52
Tie rod to Spindle	69	94
U Bolt Torque	100	136
Upper Ball Joint to Spindle	72	98
Wheel Speed Sensor Bracket to Spindle	13	18
Wheel Speed Sensor to Spindle	13	18

WARRANTY / RETURN POLICY / SAFETY

Cognito Limited Lifetime Warranty

Cognito Motorsports, Inc. hereinafter "Cognito," warrants to the original retail purchaser, that its suspension products are free from workmanship and material defects for as long as the purchaser owns the vehicle on which the product(s) were originally installed. This warranty will be void if any modifications are made to the components, including alterations to the surface finish, i.e.; painting, powder coating, plating, and/or welding, or if they are improperly installed. Cognito truck suspension products are not designed nor intended to be installed on "competition" vehicles used in race applications, stunt or for exhibition purposes that are outside of the intended operating conditions specified by the manufacturer. Racing and competition are defined as any contests between two or more vehicles; or vehicles competing individually on off road circuits in timed events (whether or not such contests are for an award or prize).

This warranty does not include coverage for police, taxi, government or commercial vehicles, and the warranty does not cover Cognito products sold outside of the USA. Cognito's obligations under this warranty are specified and applied at its sole discretion, and warranty coverage is limited to repair or replacement of the defective product(s). Any and all costs of removal, installation or reinstallation; freight charges, incidental or consequential damages associated with the covered products are expressly excluded from this warranty.

The following items are exempt from Cognito limited warranty coverage: bushings, bump stops, tie-rod ends (Heim joints) and limiting straps. These parts are "consumables" and designed to wear as a normal part of their duty cycle, therefore they are not considered defective when worn. The aforementioned products are warranted separately against defects in workmanship, for 60 days from the date of purchase. As a condition of warranty validation, respective Cognito suspension components must be installed as a complete system (not combined with non-Cognito hardware or ancillary parts). Any substitutions or omission of required components will void the warranty. Some minor cosmetic wear and imperfections may occur to parts during shipping, which is not covered under this warranty. This limited warranty does not apply to any components that have been subjected to collision damage, negligence, alteration, abuse, or misuse, and coverage does not extend to products manufactured by third-party companies. Cognito reserves the right to supersede, discontinue, or change the design, finish, part number and/or application of its parts when deemed necessary, without notice.

Return Policy

Product returns will not be accepted without prior written approval from an authorized Cognito representative. All products being returned must be shipped via trackable, prepaid freight. Returned products are subject to a 25% percent restocking fee. The eligible return period for products purchased directly from Cognito is 30 days from the verified date when the product(s) were originally received by the purchaser.

Product Safety Advisory

The installation of Cognito steering and suspension components will modify your vehicle's original factory equipment and geometry, which may cause it to handle differently than a stock (unaltered) vehicle. Installation of these components is not intended to strengthen nor reinforce the vehicle's frame, nor are they designed to increase rollover protection. It is necessary to periodically inspect all suspension and drive train components for proper attachment, torque specifications, operation, and for any potential unusual wear or damage. Installation of these parts will modify the height of the vehicle and may raise the center of gravity. Modifying vehicle height combined with off road operation may increase your vehicle's susceptibility to rollover conditions, which may cause serious injury or death. Many states regulate allowable vehicle height modifications, and it is your responsibility to know and comply with the legal requirements specified by the laws where you reside. Modifications to your vehicle's ride height may also affect the ride quality, driver input response, trackability and handling, and wear to your vehicle's suspension components and tires.