



Thank you for purchasing a Borla Performance Cat-back™ Exhaust System.

Precision manufactured using aircraft quality T-304 stainless steel; this system is designed to endure years of heavy use. Installing a Borla Performance Exhaust System on your vehicle will eliminate the restrictive design of the stock exhaust, allowing your engine to discharge exhaust gas easier. The result is more horsepower and torque, longer engine life, and a distinctive throaty growl- all this, with easy bolt-on installation. These installation instructions have been written to help you in the installation of your Borla Performance Exhaust System. Please read it completely before installing your system.

This Borla Performance Cat-back™ Exhaust System (Part number 140057) has been designed for the 2003-2005 Infiniti G35 2 door coupe equipped with a 3.5L V6 engine and automatic or manual transmissions.

Borla Performance Industries recommends that an exhaust shop or professional after market parts installer, who has all the necessary equipment, tools and experienced personnel needed for proper installation, should perform the installation of this system. However, if you decide to perform the installation, we recommend someone should help you. Ensure the installer uses all under car safety precautions including eye protection.

Please take time to read and understand the following...

By installing your Borla Performance Exhaust System, you indicate that you have read this document and you agree with the terms stated below.

It is the responsibility of the purchaser to follow all installation instruction guidelines and safety procedures supplied with your Borla Performance Exhaust System

Borla Performance Industries assumes no responsibility for damages occurring from misuse, abuse, improper installation, improper operation, lack of responsible care, or all previously stated reasons resulting from incompatibility with other manufacturer's products and/or systems.

Included with your Borla Performance Exhaust System is a warranty card. Please read it carefully before you begin any work on your vehicle. If you should have any questions regarding our warranty policy, installation, or any other matter pertaining to your new Borla Performance Exhaust System, please give us a call at the number provided on the warranty card.

Borla Performance Cat-back[®] Bill of Materials

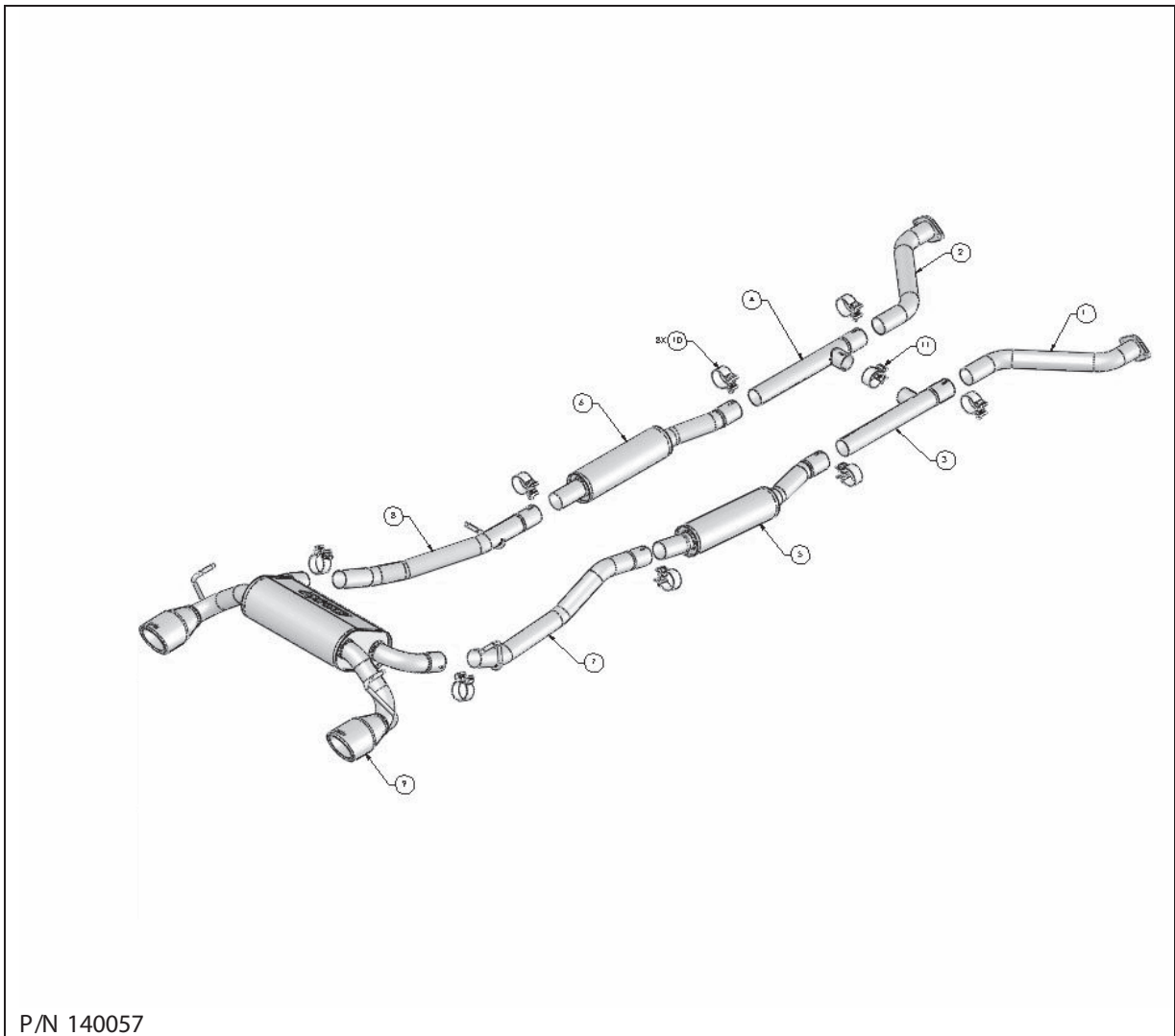

1. Right front pipe assembly
2. Left front pipe assembly
3. Right H-pipe assembly
4. Left H-pipe assembly
5. Right front muffler assembly
6. Left front muffler assembly
7. Right intermediate pipe
8. Left intermediate pipe
9. Rear muffler assembly
10. 2.25" Accuseal clamp (qty 8)
11. 2.00" Accuseal clamp (qty 1)

Caution!!! Never work on a hot exhaust system. Serious injury in the form of burns can result If the vehicle has been in use and the exhaust system is hot, allow vehicle to cool for at least 1 hour. Always wear eye protection when working under any vehicle.

Note: It is our recommendation that you use a hoist or hydraulic lift to facilitate the installation of your new Borla Performance Cat-back™ Exhaust System.

Taking all under car safety precautions, lift the vehicle using a hoist or hydraulic lift. Once this has been done, you may begin the removal of your old exhaust system from your vehicle.

Note: Before removing the original exhaust system from your vehicle, please compare the parts you have received with the bill of materials provided on the previous page to assure that you have all the parts necessary for the installation of your new Borla Performance Cat-back™ Exhaust System.

Original Exhaust System Removal

Note: With a used vehicle, we suggest a penetrating spray lubricant to be applied liberally to all exhaust fasteners and allowing a significant period of time for the chemical to lubricate the threads before attempting to disassemble.

1. Unbolt the flange shown in figure 1 located after the y-pipe assembly.
2. Remove the nut securing the ground strap from the flange just forward of the of the rear muffler assembly as shown in figure 2.



Figure 1

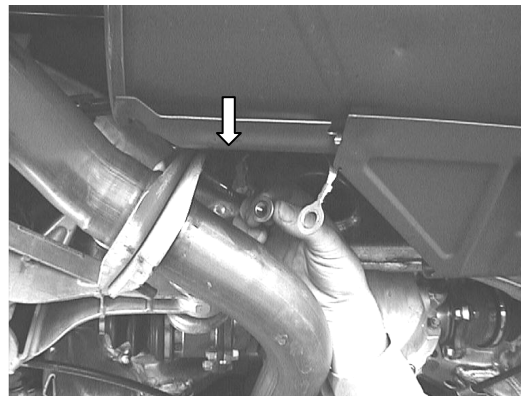

Figure 2

3. Lubricate all hangers and rubber brackets.
4. Using a muffler stand or an additional person to hold the exhaust system up in place, remove all hangers from the rubber brackets.
5. Remove the exhaust system shown in figure 4 from your vehicle.
6. Using a muffler stand or an additional person to hold Y-pipe assembly up in place, unbolt the flanges shown in figure 5 connecting the Y-pipe assembly to the catalytic converters and remove the Y-pipe assembly from the vehicle.



Figure 4

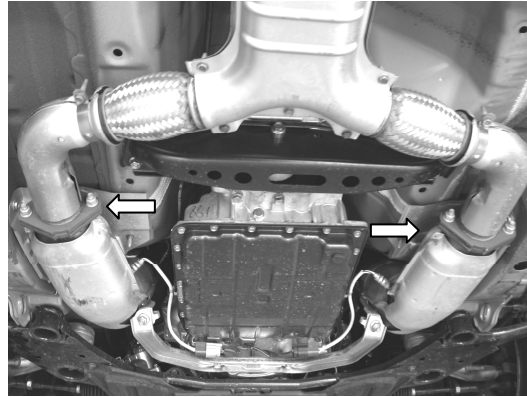

Figure 5

Borla Performance Cat-back™ Exhaust System Installation

Warning: Use extreme caution during installation. Torque all fasteners according to manufacturer's torque values and tightening sequence. **DO NOT** use air impact tools to tighten fasteners on Borla Performance Exhaust Systems. Use of such tools may result in bent flanges or gasket contact areas leading to exhaust leaks.

1. Using the original hardware and gaskets, place both left and right front pipe assemblies into position as shown in figure 6. Secure the hardware hand tight.
2. Place the only 2.25" clamp over the smallest expanded end of the left H-pipe assembly and connect it to the right H-pipe assembly. Place a clamp over each expanded end of the assembled H-pipe assembly and install it into position as shown in figure 7 sliding it over the left and right front pipe assemblies. **DO NOT** tighten the clamps.



Figure 6

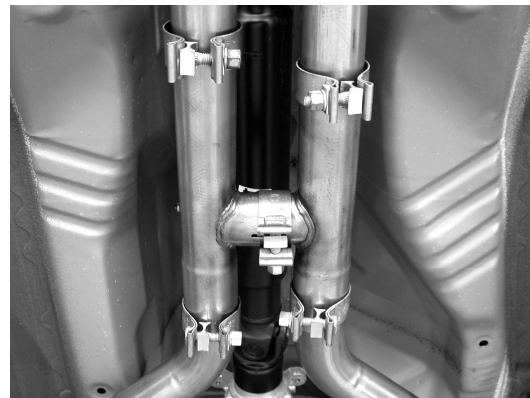

Figure 7

3. Place a clamp over the expanded end of both left and right front muffler assemblies and set them into position after the H-pipe assembly as shown in figure 8. **DO NOT** tighten the clamps.
4. Place a clamp over the expanded end of both left and right intermediate pipes and set them into position as shown in figure 9 making sure to install the hangers into the rubber brackets. **DO NOT** tighten the clamps.

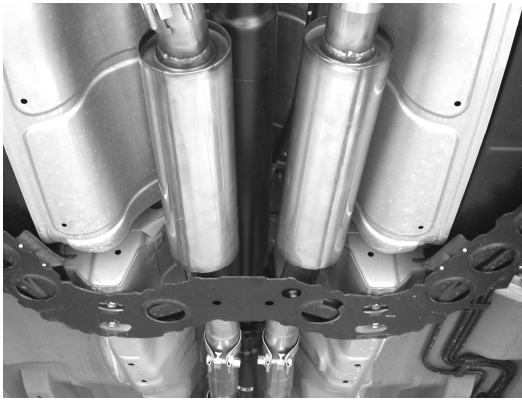

Figure 8

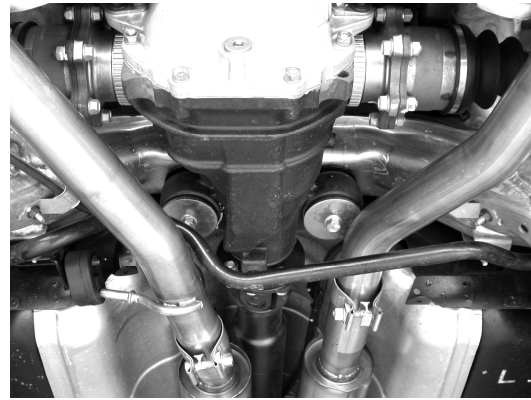

Figure 9

5. Place a clamp over each expanded end of the rear muffler assembly and set it into position as shown in figure 10 installing the hangers into the rubber brackets.
6. Completely remove bolt from clamp and place the ground strap over the threaded portion as shown in figure 11.

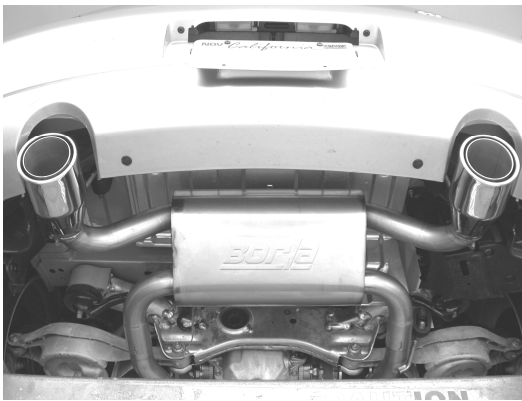

Figure 10

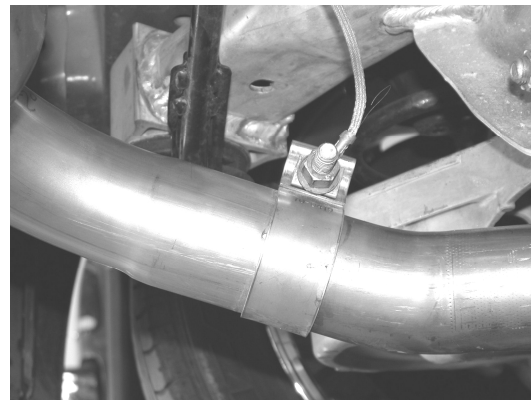

Figure 11

7. Check your exhaust system for proper clearance under the vehicle and also for tip alignment.
8. Once position has been determined to be correct, tighten the Accuseal™ clamps to 32-35 ft. lbs. and secure the flanges connecting the left and right front pipe assemblies to the catalytic converter to the vehicle manufacturer's recommendations.
9. Before starting your vehicle, make sure to check all wires, hoses, brake lines, body parts and tires for safe clearance from the exhaust system.
10. Start vehicle and check for any leaks. If any leaks are found, determine cause (such as loose or incorrectly positioned clamp) and repair as necessary.

Note: When you first start your vehicle after the installation of your new Borla Performance Exhaust System, there may be some smoke and fumes coming from the system. This is a protective oil based coating used in the manufacturing of mandrel bent performance exhaust tubing. This is not a problem and will disappear within a very short period of time after the exhaust has reached normal operating temperatures.



Congratulations!!! You have completed the installation of the world famous Borla Performance Stainless Steel Exhaust System.