

## Installation for Toyota Camry PN- 11916



**\*\*\*\*\* Please compare the parts in the box with the bill of materials provided \*\*\*\*\*  
to assure that you have all the parts necessary for this installation.**

These instructions have been written to help you with the installation of your Borla Performance Exhaust System. Please read this document completely before beginning the installation of your system.

To ensure this part number fits your specific model year, please visit our website for the latest model year listings at [www.BORLA.com](http://www.BORLA.com)

**Thank you for purchasing a Borla Performance Rear Section Exhaust System.**

**Borla Performance Exhaust (PN-11916) is designed for the Toyota Camry 3.5L V6 engine with automatic transmission.**

Borla Performance Industries recommends that an exhaust shop or professional after market parts installer, who has all the necessary equipment, tools and experienced personnel needed for proper installation, should perform the installation of this system. However, if you decide to perform the installation, we recommend someone should help you. Ensure the installer uses all under car safety precautions including eye protection.

*Please take time to read and understand the following...*

By installing your Borla Performance Exhaust System, you indicate that you have read this document and you agree with the terms stated below.

It is the responsibility of the purchaser to follow all installation instruction guidelines and safety procedures supplied with your Borla Performance Exhaust System.

Borla Performance Industries assumes no responsibility for damages occurring from misuse, abuse, improper installation, improper operation, lack of responsible care, or all previously stated reasons resulting from incompatibility with other manufacturer's products and/or systems.

Included with your Borla Performance Exhaust System is a warranty card. Please read it carefully before you begin any work on your vehicle. If you should have any questions regarding our warranty policy, installation, or any other matter pertaining to your new Borla Performance Exhaust System, please give us a call at the number provided on the warranty card.

**Minimum Required Tool List:**

**TOOLS:**

1. 3/8" Drive Ratchet
2. 3/8" Drive Extension 9"
3. 14mm Socket
4. 14mm Wrench
5. Pry Bar

**SHOP SUPPLIES:**

- 1 Spray Lubricant

**Borla Performance - Bill of Materials**

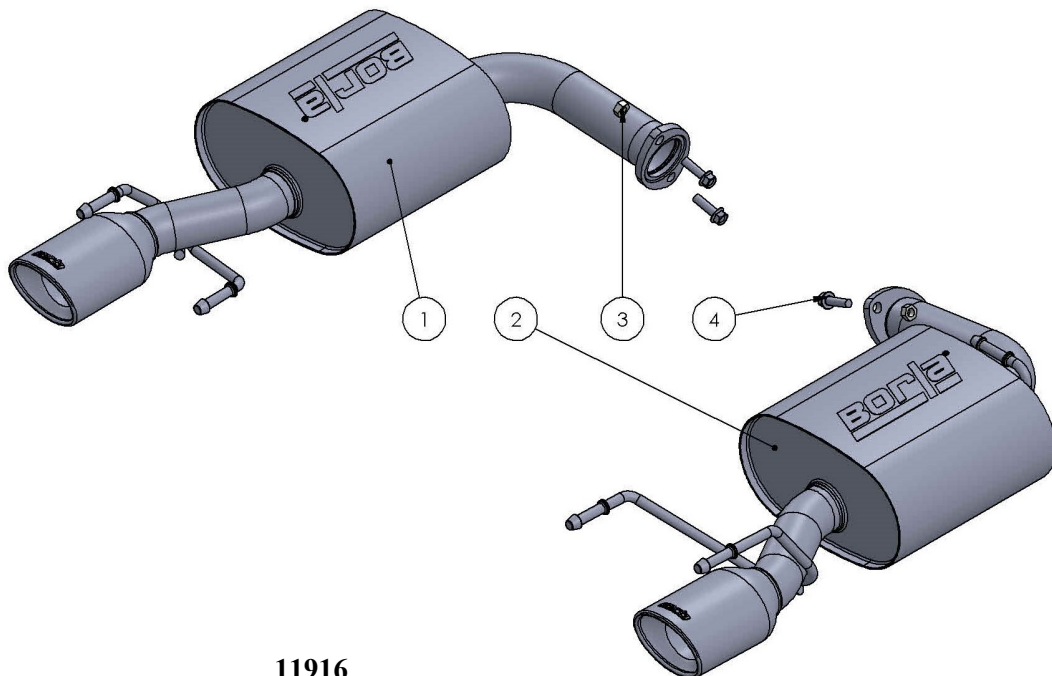

**11916**

ITEM NO.	PART NUMBER	DESCRIPTION	QTY.
1	55811	L/H MUFFLER ASSEMBLY	1
2	55812	R/H MUFFLER ASSEMBLY	1
3	11514597	NUT: HXHD, M10 X 1.50p	4
4	11515767	SCREW:FLNG,HXHD,M10x35mm,1.50mP	4

**Caution!!!** *Never* work on a hot exhaust system. Serious injury in the form of burns can result. If the vehicle has been in use and the exhaust system is hot, allow vehicle to cool for at least 1 hour. Always wear eye protection when working under any vehicle.

**Note:** It is our recommendation that you use a hoist or hydraulic lift to facilitate the installation of your new Borla Performance Exhaust System.

Taking all under car safety precautions, lift the vehicle using a hoist or hydraulic lift. Once this has been done, you may begin the removal of your old exhaust system from your vehicle.

**Note:** Before removing the original exhaust system from your vehicle, please compare the parts you have received with the bill of materials provided on the previous page to assure that you have all the parts necessary for the installation of your new Borla Performance Exhaust System.

**Note:** With a used vehicle, we suggest a penetrating spray lubricant to be applied liberally to all exhaust fasteners and allowing a significant period of time for the chemical to lubricate the threads before attempting to disassemble.

## Original Exhaust System Removal

1. Lubricate all hangers, rubber isolator, bolts, and nuts. (See Fig. 1)
2. Begin removal on the right-side muffler, loosen and remove the nuts on the rear flanges. Carefully remove the hangers from the rubber isolators and remove the muffler assembly from the vehicle. Keep hardware for installation of your new exhaust. (See Figs. 2 & 3)
3. Repeat Step 2 on the left-side muffler.
4. Carefully remove both metal gaskets from the Right-Side and Left-Side removed mufflers. (See Figs. 4 & 5)

**WARNING:** Use extreme caution during installation. Torque all fasteners according to manufacturer's torque values and tightening sequence. **DO NOT** use air impact tools to tighten fasteners on Borla Performance Exhaust Systems. Use of such tools may result in bent flanges or gasket contact areas leading to exhaust leaks.

**NOTE:** When you first start your vehicle after the installation of your new Borla Performance Exhaust System, there may be some smoke and fumes coming from the system. This is a protective oil based coating used in the manufacturing of mandrel bent performance exhaust tubing. This is not a problem and will disappear within a very short period of time after the exhaust has reached normal operating temperatures.

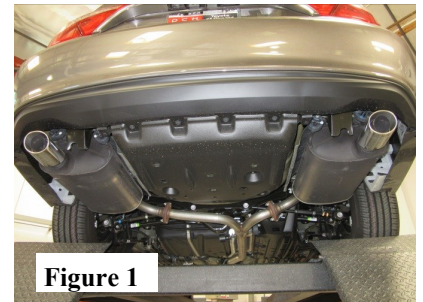

Figure 1

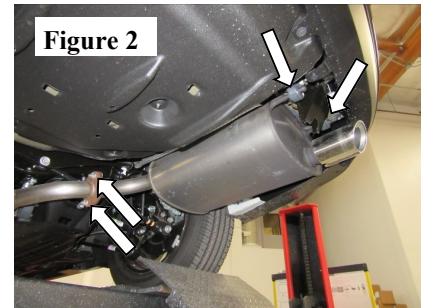

Figure 2

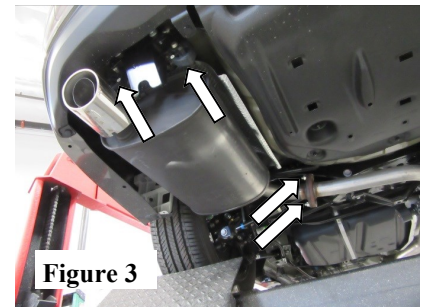

Figure 3

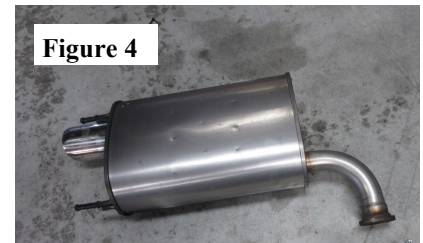

Figure 4

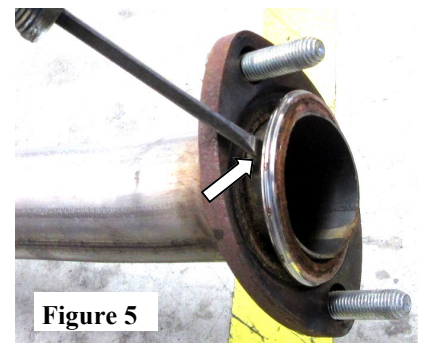
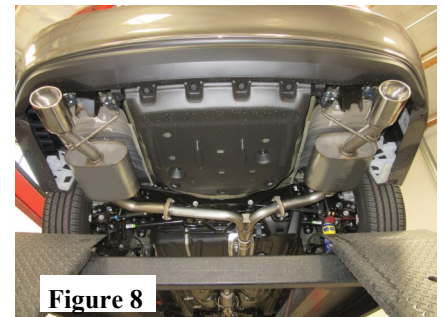
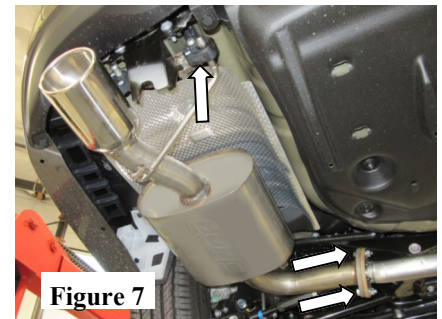
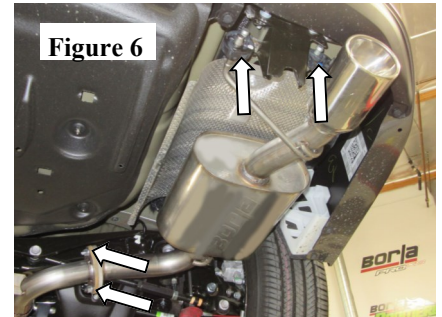

Figure 5

## Borla Performance Exhaust Installation

1. Install the **R/H Muffler Assembly** to vehicle inserting hangers into rubber isolators. (See Fig. 6 & 7)
2. Using factory hardware reinstall bolts and gasket assembly into **R/H and L/H Muffler Assembly**. (See Fig. 8)
3. Position tip 1/2" from bumper valence. Tighten hardware to 30-ft lbs torque.
4. Before starting your vehicle, make sure to check all wires, hoses, brake lines, body parts and tires for safe clearance from the exhaust system. (See Fig. 9)
5. Start vehicle and check for any leaks. If any leaks are found, determine cause and repair as necessary.



**WARNING:** Use extreme caution during installation. Torque all fasteners according to manufacturer's torque values and tightening sequence. **DO NOT** use air impact tools to tighten fasteners on Borla Performance Exhaust Systems. Use of such tools may result in bent flanges or gasket contact areas leading to exhaust leaks.

**NOTE:** When you first start your vehicle after the installation of your new Borla Performance Exhaust System, there may be some smoke and fumes coming from the system. This is a protective oil based coating used in the manufacturing of mandrel bent performance exhaust tubing. This is not a problem and will disappear within a very short period of time after the exhaust has reached normal operating temperatures.