



Installation Instructions

Vehicle Application

Year: 2014 - 2016

Make: Dodge

Model: Ram 1500

Engine: 3.0L Eco Diesel

Note: 1500 3.0L Eco Diesel Only

Tools Required

- 8mm, 10mm, 13mm Wrench & Socket
- Pin Removal Tool or Flat Blade Screwdriver
- 7/16" Wrench and Socket
- 5/16" Nut Driver or Flat Blade Screwdriver
- Phillips Screwdriver
- 1 Set of Torx Wrenches & Allen Wrenches
- 1 Pair of Pliers or similar tool

S&B Filter Maintenance

Cleanable (KF-1061). If the enclosed filter is Red, it came pre-oiled from the factory. Please visit www.sbfilters.com for the exact oil amount required after cleaning.

Disposable (KF-1061D). If the enclosed filter is White, it is a disposable filter and should be discarded once it reaches capacity. This filter (does not require oil). For more info on S&B's disposable filter, visit www.sbfilters.com.

Notes

Kit may not fit with the following Aftermarket Parts installed:

- Body Lift or Lowering Kit
- Custom Hood
- Throttle body upgrades

CARB Status - Pending

Product will be submitted to Air Resources Board for approval shortly.

Not Legal for use in CA or other states adopting CA emissions standards" See Page 4 for more info.

Before You Start

- Please read the entire product guide before proceeding.
- Ensure all components listed on page 5 are present.
- If you are missing any of the components, call our customer support at (909) 947-0015.
- Do not work on your vehicle while engine is hot.

1. With the ignition switched off and the parking brake set, disconnect the negative battery cable on the passenger side. **Note: Failure to disconnect the battery may cause the CEL to illuminate upon completion of the installation and subsequent operation. Do not skip this step!**



2. Remove the factory engine cover by pulling up and out.

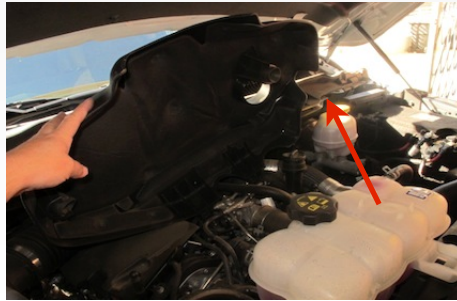

3. Disconnect the MAF sensor harness by pulling out the red latch and pushing down on the release button and pulling out.



4. Use a 5/16" nut driver to loosen the hose clamp on the MAF.



5. Pull the tube off the MAF and pull away.



6. Use a 5/16" nut driver to loosen the hose clamp on the turbo inlet.

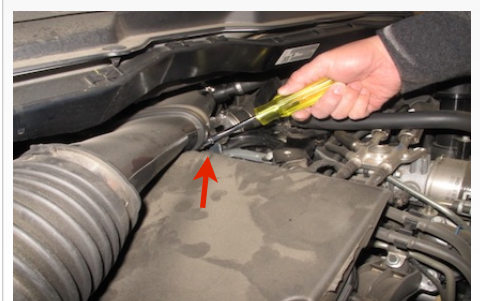

7. Remove the complete tube assembly from the vehicle.



8. Remove the lid by first removing the latches on the side of the factory air box.



9. Remove the air box lid by lifting up and out.



SEE EXPLODED VIEW ON PAGE 5



Installation Instructions (continued)

10. Remove the stock air filter.



11. Remove the harness that is attached to the side of the stock air box.



12. Remove the stock air box by pulling up and out.



13. Remove the two factory grommets on the bottom of the factory air box.



14. Install both grommets on the bottom of the S&B air box.



15. Remove the grommets from the factory air box side tabs.



16. Push both grommets into part (K) Mounting Brackets. Put brackets to the side which will be used later in the install. Note: placement of the grommet in the bracket is with the large end facing downward.



17. Remove the factory MAF from the factory lid using a T-30 torx.



18. Also remove the rubber O-ring from the factory MAF.



19. Install the MAF Adapter (B) into the S&B air box (A). Make sure it is aligned properly.



20. Install the factory MAF into the MAF Adapter in the S&B air box. This is designed to be a tight fit and may take some effort, carefully align the MAF Sensor to the Adapter.



SEE EXPLODED VIEW ON PAGE 5



Installation Instructions (continued)

21. Make sure the MAF is aligned properly and that the flanges meet together.



22. Use the provided hardware (D,E,F) to mount the factory MAF onto the S&B air box.

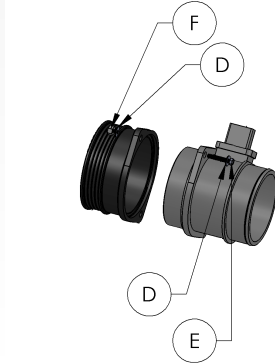

23. Assemble the S&B tube by connecting both the S&B Short Tube (W) and Long Tube (T) using the Hump Coupler (U) and the provided Hose Clamps (V). Also install Coupler (S) on the end with Hose Clamps (H).



24. Install the Filter Adapter (G) onto the S&B Air Filter (J). Use a screw driver to lineup the S&B logo on the filter straight with the (-) on the part number of the Adapter



25. Once aligned tighten down the down clamp.



26. Install the Hose Clamp (H) onto the MAF Adapter (B).



27. Install both Mounting Brackets (K) with grommets inside the vehicle on the plastic post.

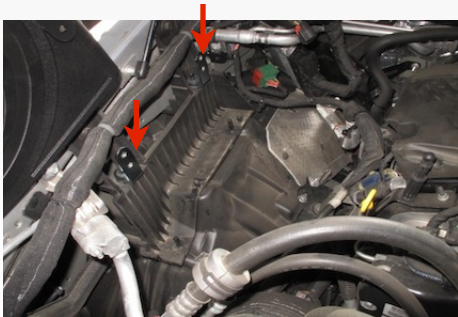

28. Install the S&B air box, make sure the bottom grommets align with the factory plastic post underneath.



29. Use the provided hardware (L&M) to attach the S&B air box to the brackets.



30. Reconnect the factory harness to the MAF.



31. Install the S&B tube assembly and connect to the factory turbo inlet and tighten the hose clamp.



32. Slide the coupler towards the S&B air box over the MAF. Tighten down the hose clamp and make sure the tube is aligned properly.



SEE EXPLODED VIEW ON PAGE 5



Installation Instructions (continued)

33. Install the provided Lid Seal (O) onto the S&B Lid (N).



34. Install the S&B Filter with Adapter and tighten down Hose Clamp (H) on the MAF Adapter. Note: Make sure the Filter Adapter is fully inserted into the MAF Adapter, also make sure the top of the filter is just under the top of the air box.



35. Install the Lid (N) onto the S&B air box using the provided hardware (P&Q) and the install is complete. Please make sure all hose clamps and hardware are tightened.



36. Note: The optional Box Plug (R) may be removed to provided maximum airflow when ambient engine heat is not a factor.

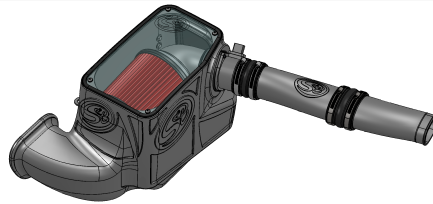

Related Items to Your Purchase

- Replacement Air Filter (Oiled) (S&B P/N: KF-1061)
- Replacement Air Filter (Dry) (S&B P/N: KF-1061D)
- Air Filter Wrap (S&B P/N: WF-1041)

Testing and Maintenance

- Engage parking brake and start your engine. Listen for abnormal noises. If an air leak is detected, re-inspect hoses and connections as they may need to be repositioned and tightened.
- S&B FILTERS recommends that you keep your OE intake system in the event it is required in the future.
- In order to maintain your warranty, all connections and components must be checked periodically for alignment and for proper tension on all connections. Regularly check the filter to see if it needs cleaning (Oiled Filter) or needs to be replaced (Dry or Damaged Filter). Failure to do so may void your warranty.
- Use only S&B FILTERS cleaning and oil products to service your filter. Using any other brand oil and or cleaners on your S&B air filter may void your warranty. See www.sbfilters.com for complete warranty information.

Precision II Filter Cleaning & Oiling



Order online today at www.sbfilters.com or through your local S&B distributor.
Part #: 88-0008

Warning!

If your vehicle has a Vehicle Emission Control Information decal affixed to the factory airbox, a new replacement label must be obtained and installed in a readily visible position in the engine compartment in order to remain CARB compliant. Failure to do so will prevent the vehicle from passing a smog check. Replacement labels can be ordered from your local dealership. Regulations state that the VECI label shall not be affixed to any equipment which is easily detached from the vehicle. Label placement, under the hood on a painted surface is recommended.

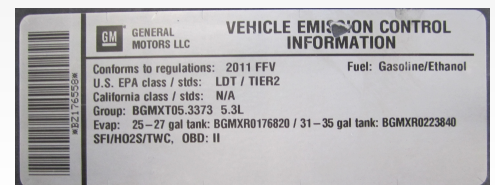

Emissions Standard

The California Air Resource Board (CARB) requires that an E.O. identification label be applied to the vehicle in order to pass a smog check inspection when a Performance Intake Kit has been installed. You must place the E.O. label provided on or near the intake kit after installation so that a smog check technician can easily verify the E.O. number. Check the status of the exemption process by looking up a specific part number at www.sbfilters.com. The CARB Exemption number and/or status is listed under the Product Details section for each part number. If the status shows as "Pending," CARB has yet to issue an exemption. Products that have not been issued an EO number are street legal in most states, but may not be used on emission controlled vehicles in the state of California and are for off road use only. If you purchased your kit from S&B Filters directly, we will automatically mail you your Exemption Sticker when it is issued to us. If you purchased your kit from an authorized S&B Filters Dealer, log onto our web site and register to receive your Exemption Sticker.

SEE EXPLODED VIEW ON PAGE 5



Exploded View

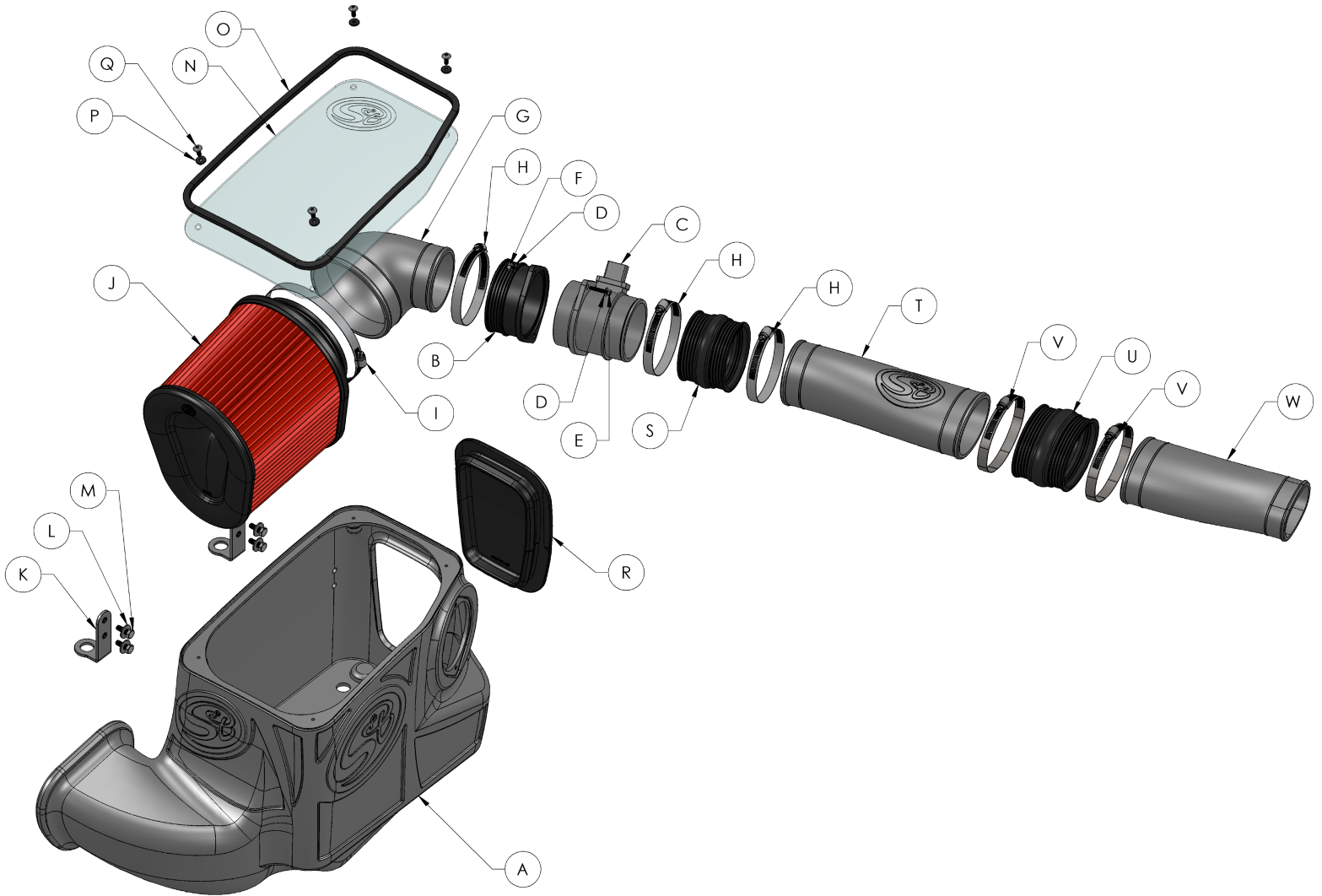

ITEM	QTY.	DESCRIPTION	P/N
A	1	Intake Box	AL1228B-00
B	1	MAF Adapter	AI1672C-00
C	1	Factory MAF	
D	4	3/16" Washer	AI1698-00
E	2	8-32 Screw	AI1697-00
F	2	Locknut 8-32	AI1699-00
G	1	Filter Adapter	AL1228A-00
H	3	Hose Clamp #52	AG1007-00
I	1	Hose Clamp #88	AG1011-00
J	1	S&B Air Filter	KF-1061
K	2	Mounting Bracket, Air Box	AI1677-00
L	4	Washer 1/4"	AI1073-00
M	4	Screw 1/4-20	AI1068-00
N	1	Box Lid	AI1675-00

ITEM	QTY.	DESCRIPTION	P/N
O	1	Lid Seal	AI1636-04
P	4	Washer#10	AI1540-00
Q	4	Screw 10-24	AI1539-00
R	1	Box Plug	AI1673C-00
S	1	Hump Coupler 3" x 2.5"	AI1601C-00
T	1	Long Tube	AL1228L-00
U	1	Hump Coupler 3.5" x 2.75"	AI1321C-00
V	2	Hose Clamp #60	AG1008-00
W	1	Short Tube	AL1228S-00

AM0219-00 REV E 08/24/2018

Warranty

Visit www.sbfilters.com for complete warranty information.