

#38

INSTALLATION MANUAL

FOR 24 VALVE 5.9L CUMMINS POWERED **DODGE TRUCKS** 1998 ½ THROUGH 2002



MODEL FRRP-150

***FACTORY REPLACEMENT RAPTOR PUMP
WITH BIG LINE KIT***

**READ THESE INSTRUCTIONS THOROUGHLY
BEFORE BEGINNING INSTALLATION**

PureFlow AirDog

705 MAUSOLEUM ROAD
SHELBYVILLE, IN 46176

1-877-421-3187

WWW.PUREFLOWAIRDOG.COM

RAPTOR **Fuel Pumps**



*Adjustable
Regulator*

MOUNTS IN THE SAME LOCATION AS THE OE TRANSFER PUMP



OVERVIEW



Welcome to the **Raptor™ FRRP Fuel Pump**

The Raptor™ FRRP-150 Fuel Pump is a Premium high output replacement lift pump for the Dodge Cummins 24 Valve 5.9L diesel engine. A complete installation kit is included.

The output pressure for the 5.9L 24 Valve Cummins engine is factory set at 14/16 PSI.

Pressure and flows are approximate as they will vary with fuel temperature and as the brushes wear in.

The FRRP-150 is for stock 5.9L Cummins Diesels.

The Raptor™ FRRP-150, a gerotor fuel pump, features an adjustable pressure regulator

SAFETY GUIDELINES!

The installation of the **Raptor™ FRRP Fuel Pump** can be made easy by following the steps outlined in this manual.

1. Inventory the package components completely. Notify *PUREFLOW AIRDOG* immediately of any parts missing or damaged.
2. Read the installation manual and understand how the system operates before beginning installation.
3. If any installation procedure is uncertain, contact *PUREFLOW AIRDOG* for technical assistance.

NOTE: SOME OF THE PICTURES USED IN THIS MANUAL ARE FOR EXAMPLE ONLY AND MAY NOT PICTURE A COMPONENT EXACTLY THE SAME AS FOUND IN YOUR TRUCK.

CAUTION: Chock the vehicle's tires to prevent rolling.

CAUTION: Disconnect the battery cables to both batteries before proceeding with the Raptor™ Fuel Pump installation.

CAUTION: Wear safety glasses when operating power tools such as drills and grinders or when using a punch or chisel.

**Use Good Judgment and Common Sense
When Installing the Raptor™ FRRP-150**

QUICK CONNECT COMPONENT OVERVIEW

Provided in this kit is an OE style quick connection system. This system allows a quick, clean, and professional install.

SAE J2044 Quick Connect System

The SAE J2044 quick connect system is the most commonly used system in the automotive industry. The images below show the formation of SAE J2044 connection. To connect the assemblies, simply insert the male end form into the mating female connector. Push firmly until you hear it “click” into place. To disconnect the fittings, press down and hold the tabs on the female connector while you firmly pull the assembly apart.



Parts List







QTY	DESCRIPTION	PART NUMBER	IMAGE
1	Factory Replacement Raptor™ Pump (FRRP)	FRRP-150	
1	Mounting Hardware Kit	901-61-0102-FRRP	
1	Customer Service Oring Replacement Kit	906-05-0100	
1	1/2" Male QC x 3/4-16 ORB	08J2044-3/4UNF	
2	2ft of Fuel Line	HS02	
4	1/2" 90° Hose Quick Connect Fitting	FQC1290	
3	12mm X 1/2" Male SAE J2044 Quick Connect Fitting	WAP 102	
5	Sealing Washer (installs on WAP102 fitting and factory inlet banjo)	1P-5-DS	

ILLUSTRATION OF COMPONENTS



INSTRUCTIONS

REMOVING THE STOCK PUMP

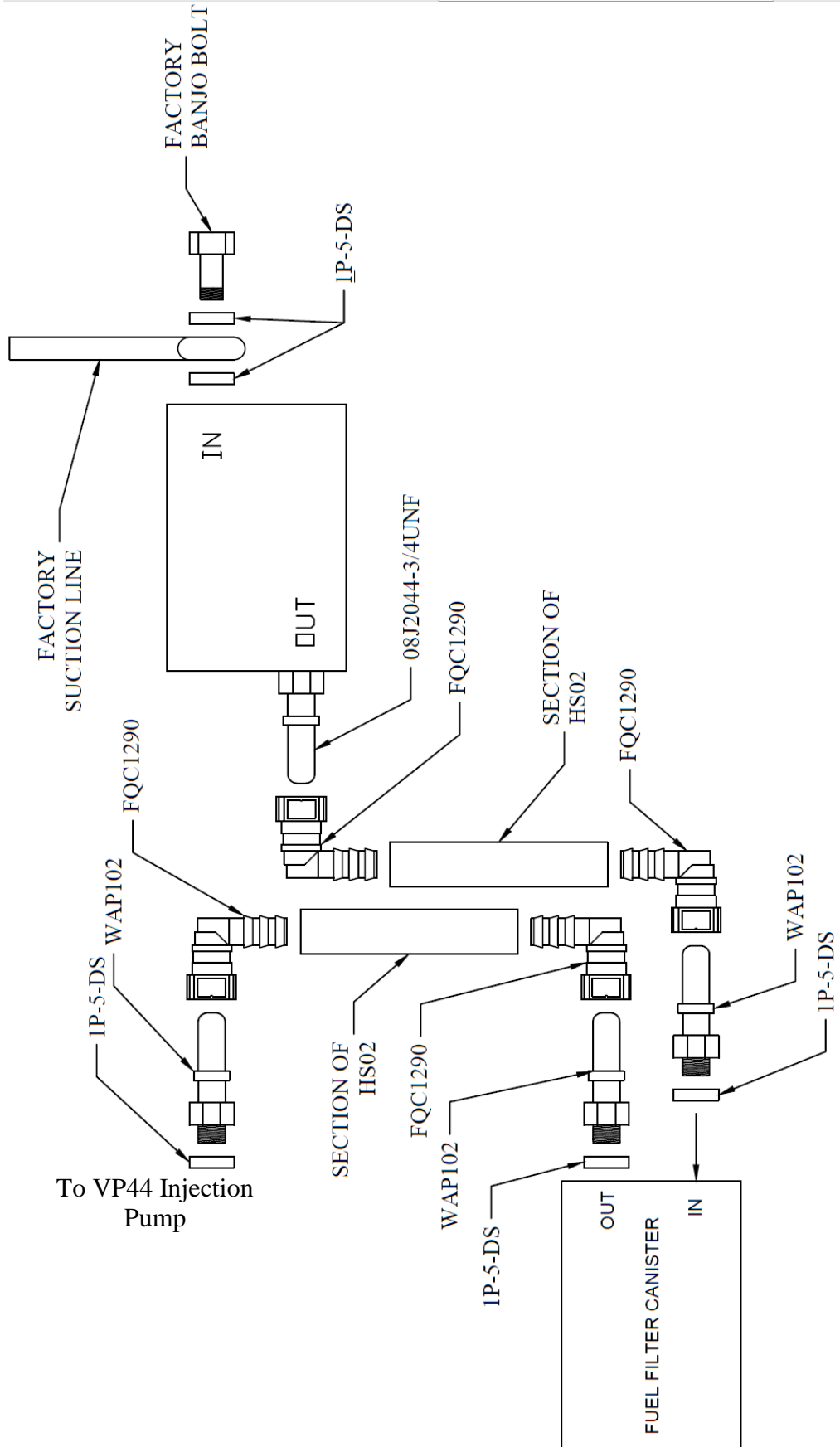
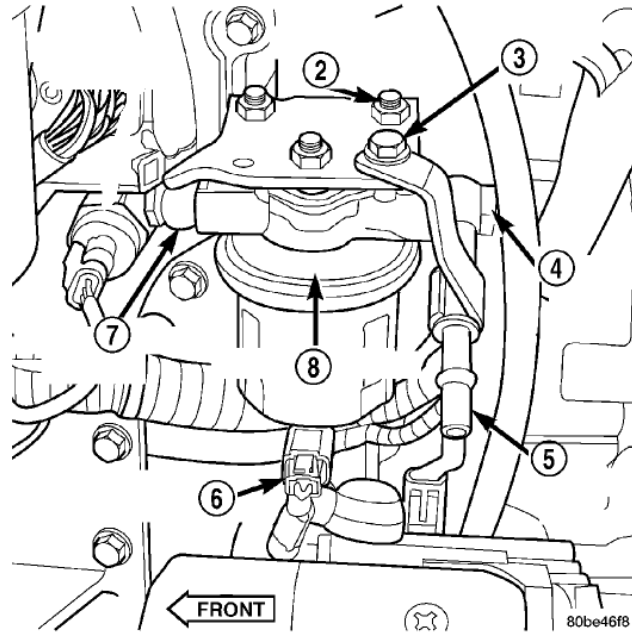

Fuel Transfer Pump Location

- 2 - PUMP BRACKET NUTS (3)
- 3 - SUPPORT BRACKET BOLT
- 4 - BANJO BOLT (REAR)
- 5 - FUEL SUPPLY LINE
- 6 - ELECTRICAL CONNECTOR
- 7 - BANJO BOLT (FRONT)
- 8 - FUEL TRANSFER PUMP

FIG 1. (SOURCE: alldatapro.com)

1. Disconnect the electrical connector. Reference #6 of Fig. 1
2. Remove the banjo fitting on the inlet side of the stock fuel pump. Reference #4 of Fig 1.
Do not discard this banjo fitting. It will be reused.
3. Remove the banjo fitting from inlet of the filter canister.
4. Remove the fuel line support from the mounting bracket. Reference #3 of Fig 1.
5. Remove the 3 mounting nuts at the top of the bracket. Reference #2 of Fig 1.
6. The stock pump along with the outlet hose can now be completely removed from the vehicle.

Assembling the Fuel Lines

This kit includes a length of fuel line and separate fuel line ends to allow for much cleaner looking installations! Assemble the fuel lines as you install them. You won't want to pre-assemble the hoses or your lengths may be off.

1. Take the fuel line end and lubricate the barbed end with clean motor oil (Figure 2) and press it into the fuel line (HS02) until all three barbs are covered (Figures 3 and 4). The fuel line end should look like Figure 4.



Figure 2



Figure 3



Figure 4

2. Now plug that fuel line with that fitting into the connection on the either the Raptor or the truck where the manual calls it out.
3. Run the fuel line away from any hot or moving parts such as exhaust or the driveshaft. Cut the hose to length and insert the other fuel line end that the manual calls out into the fuel line as outlined in step 1.

NOTE: Hose clamps are not needed for these push-lock connectors.

INSTALLING THE FRRP-150

1. Replace the 2 original sealing washers on the stock banjo fitting with the 2 new ones provided (part# 1P-5-DS). And firmly tighten the factory fuel supply line in the inlet port of the FRRP using the factory banjo fitting. The factory support bracket is no longer used.
2. Install the 08J2044-3/4UNF fitting in the port labeled "Out," using a 7/8" Wrench. Reference Figure 5.

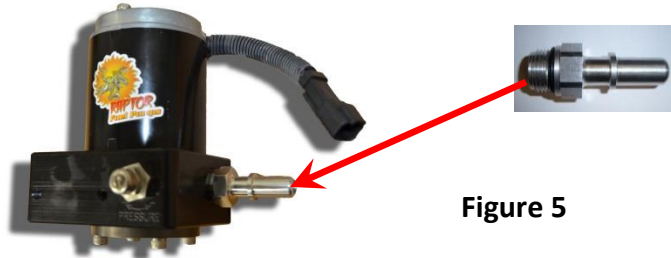

4. Firmly tighten the FRRP to the stock bracket using the hardware supplied. See Fig 6



5. Install the 12mm X 1/2" Male SAE J2044 Quick Connect Fitting (part# WAP102) with seal washer supplied (1P-5-DS) into the inlet port on the fuel filter canister. Do not over tighten. The fitting could crack or break! See Figures 7 & 8.

1998.5 - 1999



Figure 7

2000 - 2002

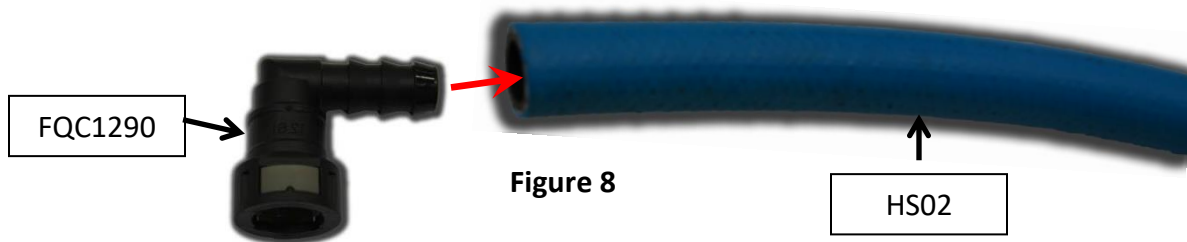

Figure 8

Note: Figures 7 & 8 depict a push lock style connection. This kit is supplied with connects as shown in the parts list.

INSTALLING THE FRRP-150 CONTINUED

6. Assemble one end of the hose (Reference the fuel line assembly section) using fuel line end FQC1290 and plug it into the WAP102 fitting installed in the filter canister “inlet” in the previous step. A “click” will be heard once the fitting is properly connected.



7. Run the fuel line to the port in the FRRP labeled “Out” and cut the fuel line to length. Press in fuel line end FQC1290 per the fuel line assembly section and install it on the previously installed 08J2044-3/4UNF fitting. A “click” will be heard when properly installed.

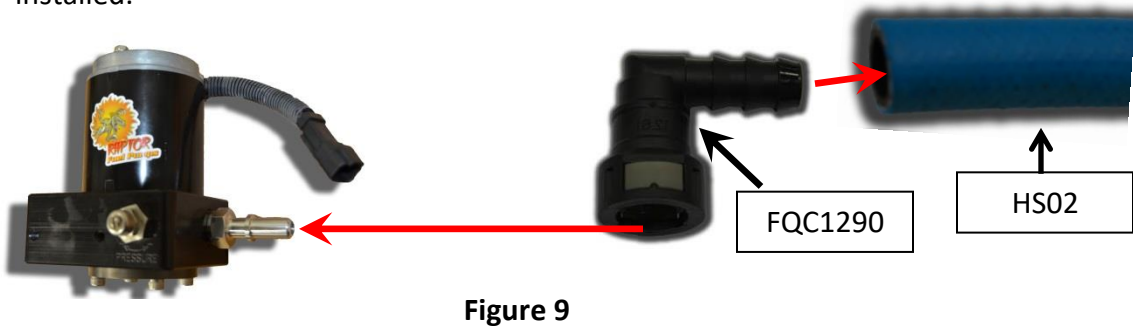

INSTALLING THE BIG LINE KIT

1. Remove the factory banjo bolt (Figure 10) and discard the fuel hard line that runs between the filter canister and the injection pump. Install the seal washer "1P-5-DS" and "WAP 102" male quick connect to the inlet port of the injection pump. (See Figure 11)

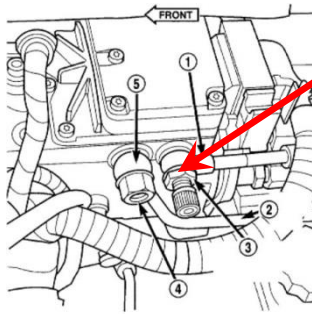

Figure 10

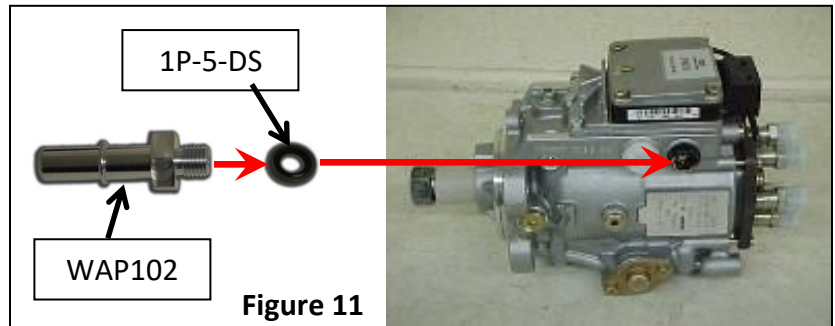
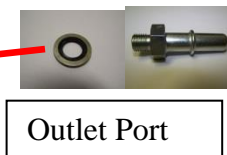

Figure 11

2. Install the male quick connect fitting "WAP 102" with seal washer "1P-5-DS" into the outlet port of the fuel filter canister.



Figure 11



Outlet Port



Figure 12

Note: Figures 11 & 12 depict a JIC connection. This kit is supplied with quick connects as shown in the parts list.

3. Assemble one end of the hose (Reference the fuel line assembly section) using fuel line end FQC1290 and plug it into the WAP102 fitting installed in the filter canister "outlet" port in the previous step. A "click" will be heard once the fitting is properly connected.

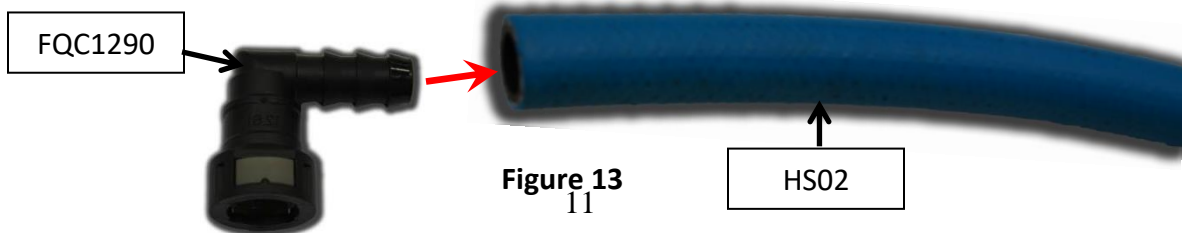
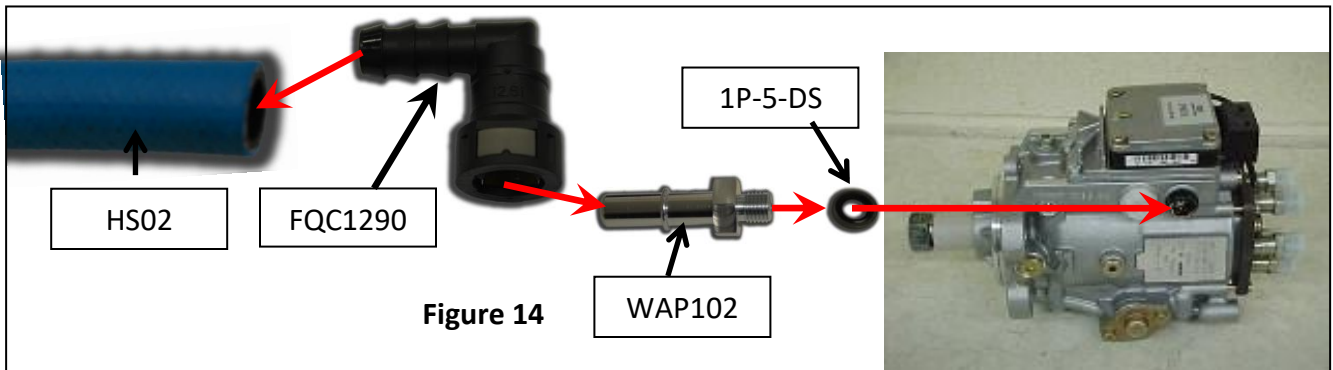

Figure 13

INSTALLING THE BIG LINE KIT CONTINUED

4. Run the fuel line to VP44 injection to where the fitting was previously installed and cut the fuel line to length. Press in fuel line end FQC1290 per the fuel line assembly section and install it on the previously installed WAP102 fitting. A “click” will be heard when properly installed.



Connect the factory power lead to the lead from the motor of the FRRP-150.

INITIAL START PROCEDURE

1. Turn the starter key to the on/run position.
Note: It may be necessary to bump the starter for the ECM to energize the **Raptor™ FRRP-150 Fuel Pump**.
2. While the **Raptor™ FRRP-150 Fuel Pump** is on, bleed the fuel line to the filter canister by disconnecting the quick connect at the canister. As soon as the line is purged of air and fuel is observed, quickly reinstall the female quick connect. A click will be heard when properly installed.
3. Start engine!

Adjusting the Pressure Regulator

NOTE: PureFlow AirDog strongly recommends the use of a fuel pressure gauge to monitor the output pressure on all of its fuel systems.

To adjust the fuel pressure, loosen the lock nut on the regulator adjustment screw. Using a flat blade screw driver, rotate the adjustment screw clockwise to increase pressure or counter clockwise to decrease pressure. Be careful not to loosen the regulator assembly base. If you do, tighten it immediately. When finished, properly torque the regulator adjustment screw lock nut!

Properly tighten the adjustment screw **Lock Nut** when finished.



RECHECK ALL FUEL FITTINGS FOR LEAKAGE AND PROPERLY TORQUE AS NECESSARY. BE SURE ALL FUEL LINES ARE PROPERLY ROUTED TO PROTECT FROM EXCESSIVE HEAT AND SECURED TO PROTECT FROM CHAFFING AND ABRASION. RECHECK ALL ELECTRICAL LINES, SECURE AS NECESSARY.

PUREFLOW AIRDOG
4 YEAR LIMITED EXPRESS WARRANTY

FOR
Raptor™ FRRP-150

IMPORTANT NOTICE

TO ACTIVATE YOUR PUREFLOW AIRDOG WARRANTY, YOU MUST COMPLETE AND MAIL YOUR WARRANTY CARD TO PUREFLOW AIRDOG WITH A COPY OF YOUR ORIGINAL SALES RECEIPT WITHIN 30 DAYS OF PURCHASE. FAILURE TO COMPLETE AND SUBMIT YOUR WARRANTY CARD WILL RESULT IN A WARRANTY PERIOD OF THE COVERED PRODUCT TO ONE (1) YEAR FROM THE DATE OF PURCHASE.

PureFlow AirDog (hereafter collectively, “SELLER”) warrants and guarantees only to the Original Purchaser (hereafter collectively, BUYER) that All PureFlow AirDog Systems (hereafter collectively, PRODUCT) shall be free from defects of materials and workmanship in the manufacturing process for as long as the BUYER owns the PRODUCT.

The 4 Year Limited Express Warranty is limited to the PRODUCT purchased by the original BUYER of the PRODUCT and limited solely to the parts contained within the PRODUCT and EXCLUDES ALL ELSE. The BUYER must follow the Warranty Procedure for any PRODUCT that is in question of Warranty. All Warranty claims are subject to the approval of PureFlow AirDog. If it is determined that a Warranty claim exists, PureFlow AirDog will, at its sole discretion, replace the defective PRODUCT with a comparable PRODUCT, repair the defective PRODUCT, or refund the BUYER’S purchase price in exchange for the PRODUCT. Repairs or replacements are warranted for only the remainder of the original warranty period and only to the original BUYER.

Under no circumstances shall the SELLER be liable for any labor charged or travel time incurred in the diagnosis for defects, removal, or reinstallation of the PRODUCT, or any contingent expense.

Under no circumstances will the SELLER be liable for any damage or expense incurred by reason of the use or sale of the PRODUCT.

Other than expressly set forth herein, the SELLER shall in no way be responsible for the proper or improper use and service of the PRODUCT. In no event shall the SELLER be liable for any special, incidental, indirect or consequential damages of any kind or nature, whether or not the BUYER of the PRODUCT was advised of the possibility of damage or harm, arising or resulting from the use or performance of the PRODUCT and BUYER hereby waives the right to any and all such claims.

BUYER, acknowledges that he/she is not relying on SELLER’S skill or judgment to select or furnish goods suitable for any particular purpose and that SELLER has no liability that will extend beyond the scope of the LIMITED EXPRESS WARRANTY contained herein, and BUYER hereby waives all remedies or liabilities, expressed or implied, arising by operation of law or otherwise.(including, without limitation, any obligation of SELLER with respect to fitness for any particular purpose; merchantability; and special, incidental, indirect or consequential damages) or whether or not occasioned by SELLER’S negligence.

SELLER disclaims any warranty and expressly disclaims any liability for personal injury or damages related to BUYER’S use of the PRODUCT. BUYER acknowledges and agrees that the disclaimer of any liability for personal injury is a material term for this agreement and BUYER agrees to indemnify SELLER and hold SELLER harmless from any claim related to the PRODUCT and its use or performance. Under no circumstances will SELLER be liable for any damages, liabilities, costs or expenses incurred as a result of or by reason of use, performance or sale of the PRODUCT, including without limitation, any damages, liabilities, costs or expenses incurred by reason of BUYER’S negligence related to those uses of the PRODUCT.

The proper installation of the PRODUCT is the sole responsibility of the BUYER. The SELLER assumes no liability regarding improper installation or misapplication of the PRODUCT.

SELLER hereby provides the following limited warranty as to description, quality, merchantability, fitness for the PRODUCT’S purpose, productiveness, or any other matter of SELLER’S PRODUCT sold herewith. The SELLER shall be in no way responsible for the open use and service of the PRODUCT and the BUYER hereby waives all

rights other than those expressly written herein. This Warranty shall not be extended or varied except by a written instrument signed by SELLER and BUYER.

IN THE EVENT THAT THE BUYER DOES NOT AGREE WITH THIS AGREEMENT, THE BUYER MAY PROMPTLY RETURN THE PRODUCT, IN A NEW AND UNUSED CONDITION, WITH A DATED PROOF OF PURCHASE, TO THE PLACE OF PURCHASE WITHIN THIRTY (30) DAYS FROM THE DATE OF PURCHASE FOR A FULL REFUND. THE BUYER AGREES THAT THE INSTALLATION OF THIS PRODUCT CONFIRMS THE BUYER HAS READ AND UNDERSTANDS THIS AGREEMENT AND ACCEPTS THE TERMS AND CONDITIONS OF THIS AGREEMENT.

Warranty Procedure

In the unlikely event a warranty appears as if it may be warranted, the following steps are taken:

- 1 The customer discussed the symptoms of the problem with a PureFlow AirDog Technician. The customer is to have the system Serial Number and Model Number available for the Technician when the call is made. This will expedite all steps of the process.
- 2 The customer performs any and all tests requested by the PureFlow AirDog Technician. This is done to isolate the potential problem while eliminating potential installation or maintenance related issues,
- 3 If the PureFlow AirDog Technician determines based on the customer feedback concerning the requested testing that system may be at fault, the customer is advised that all returned pumps are tested upon arrival and should this returned pump perform at design criteria upon arrival, the customer will be charged a \$50.00 fee.
- 4 The PureFlow AirDog Technician will first request the customer's phone number in the event the phone call is accidentally disconnected and then transfer the customer to a PureFlow AirDog Customer Service Representative. Should a Customer Service Representative not be available, the Technician will offer the Customer the option to hold, call back, or receive a return call.
- 5 The PureFlow AirDog Customer Service Representative will check to determine if the customer's Warranty Registration Card is on file.
 - a. If no Warranty Registration is found, the customer will be required to supply the original purchase receipt showing the purchase date.
 - b. If no Warranty Registration is found, the customer will be advised of the options should the system in question is out of the default warranty period (1 year).
- 6 The PureFlow AirDog Customer Service Representative will request the customer information, including: Name, Address, Phone Number, Model Number, Serial Number, Year / Make / Model of vehicle, Name of Dealer purchased from, Purchase Date, Description of Problem, Customers' understanding of the resolution, and customer credit card information.
- 7 PureFlow AirDog will cover Ground Shipping charges to ship the replacement unit and will include a prepaid shipping label for the return of the defective unit. Any additional items ordered at the time of the replacement shipment will include their portion of the shipping cost.
- 8 A period of 15 Calendar Days from the time of shipment is provided for the receipt of the defective unit at the PureFlow AirDog facility. Failure to return ship the defective unit to arrive within the defined time period will result in a charge of \$250.00 against the customer's credit card as the purchase cost of the defective unit.